

User Guide

EVGA Z170 FTW

Specs and Initial Installation

Table of Contents

Before you Begin.....	4
Parts Not in the kit.....	5
Intentions of the kit.....	5
Motherboard Specifications.....	6
Unpacking and Parts Descriptions.....	8
Equipment.....	8
Component legend.....	10
PCI-E Slot Breakdown.....	11
Rear I/O Panel legend.....	12
Preparing the Motherboard.....	13
Installing the CPU.....	13
Installing the Cooling Device.....	14
Installing System Memory (DIMMs).....	15
Installing the Motherboard.....	16
Installing the I/O Shield/Cover.....	16
Securing the Motherboard to the case.....	17
Connecting Cables.....	19
24 Pin ATX Power.....	20
EPS 8 Pin 12v Power.....	20
Connecting Internal Headers.....	21
Front Panel Header.....	21
Fan Header.....	22
USB Headers.....	23
Front Panel Audio.....	24
S/PDIF Header.....	24
Thunderbolt GPIO.....	25
EVGauge.....	25
Probe It.....	26
SATA3/6G & SATA Express.....	26
6pin PCI-E.....	27
PCI-E and M.2 Slots.....	28
Onboard Buttons.....	29

Clear CMOS Button.....29
Reset and Power button.....29
Post Debug LED and LED Status Indicators.....30
Post Port Debug LED.....30
LED Status Indicators.....30
Installing Drivers and Software.....31
Windows 10/8/7 Driver Installation.....31
POST Codes.....32
AMI POST Codes.....32
Glossary of Terms.....36
Compliance Information.....39

Before You Begin...

Mainstream performance has been redefined, introducing the EVGA Z170 FTW. The Z170 platform is the first mainstream chipset to feature DDR4 memory, and the new 6th Generation Intel® Core™ Processors! Features upgrades to the already top notch UEFI interface, 5 phase VRM, 1 M.2 slot, Native SATA 3/6G and USB3, 2 way SLI, Intel NIC, and more sitting on an 6 layer PCB.

As with any EVGA motherboard, it's designed for the overclocker. Built from the ground up to give you all the essentials that you need for overclocking, and stability, with a GUI BIOS/UEFI that is focused on functionality, high quality components and next generation dual channel DDR4 memory.

With these features and more, it is clear that the EVGA Z170 motherboards are engineered to set the new standard for the mainstream chipset motherboard.

Parts NOT in the Kit

This kit contains all the hardware necessary to install and connect your new EVGA Z170 FTW Motherboard. However, it does NOT contain the following items that must be purchased separately in order to make the system fully functional and install an Operating System:

- ❑ **Intel Socket 1151 Processor**
- ❑ **DDR4 System Memory**
- ❑ **CPU Cooling Device**
- ❑ **PCI Express Graphics Card**
- ❑ **Power Supply**
- ❑ **Hard Drive or SSD**
- ❑ **Keyboard / Mouse**
- ❑ **Monitor**
- ❑ **(Optional) Optical Drive**
- ❑ **Operating System**

EVGA assumes you have purchased all the necessary parts needed to allow for proper system functionality. For a full list of supported CPUs on this motherboard, please visit www.evga.com/support/motherboard

Intentions of the Kit

This kit provides you with the motherboard and all connecting cables necessary to install the motherboard into a PC case.

When replacing a motherboard in an existing PC, you will need to reinstall an operating system even though the current storage drive may already have one installed.

Motherboard

Motherboard Specifications

- ❑ **Size:**
 - ATX form factor of 12 inches x 9.6 inches
- ❑ **Microprocessor support:**
 - Intel Socket 1151 Processor
- ❑ **Operating Systems:**
 - Supports Windows 10 / 8 / 7
 - For Windows 7 users, please remember drivers are REQUIRED for USB3 and above support.
- ❑ **Contains Intel Z170 chipset**
- ❑ **System Memory support:**
 - Supports Dual channel DDR4 up to 3200MHz+.
 - Supports up to 64GB of DDR4 memory.
- ❑ **USB 2.0 Ports:**
 - 2x from Intel Z170 PCH, on I/O Panel
 - Supports hot plug
 - Supports wake-up from S3 and S4 mode
 - Supports USB 2.0 protocol up to a 480 Mbps transmission rate
- ❑ **USB 3.0 Ports:**
 - 8x from Intel Z170 PCH – 6x external on I/O panel, 2x internal (1 Header)
 - Supports transfer speeds up to 5Gbps
 - Backwards compatible USB 2.0 and USB 1.1 support
- ❑ **SATA Ports:**
 - Intel Z170 PCH Controller
 - 6x SATA 3/6G (600 MB/s) data transfer rate
 - Support for RAID 0, RAID 1, RAID 5, AND RAID 10
 - Supports hot plug
- ❑ **Onboard LAN:**
 - 1x Intel i219 Gigabit Ethernet PHY
 - Supports 10/100/1000 Mb/sec Ethernet

❑ **Onboard Audio:**

Realtek HD Audio (ALC1150)
Supports 8-channel (7.1) audio
Supports Optical Output

❑ **Power Functions:**

Supports ACPI (Advanced Configuration and Power Interface)
Supports S0 (normal), S3 (suspend to RAM), S4 (Suspend to disk - depends on OS), and S5 (soft - off)

❑ **Expansion Slots:**

4x PCI-E 3.0 1x16/8, 1x8, 1x4 (4 lanes from PCH), 1x1 (1 lane from PCH) slots

1x PCI-E 3.0 1x4 (4 Lanes from PCH) slot

1x M.2 Key M (PCIE + SATA)

-Key M has speeds up to 32Gbps (PCIE3.0 4x or SATA3) shared with
2x native SATA (Ports 4 and 5)

❑ **SLI and Crossfire support:**

2 Way SLI and Quad SLI (dual processor cards are required to be Gen3 NATIVE)

2 Way Crossfire and Quadfire (dual processor cards are required to be Gen3 NATIVE)

❑ **2x Video Out (on I/O Panel):**

-1x DP 1.2

-1x HDMI 1.4

❑ **7x Fan Headers:**

-2x PWM Fan headers supporting up to 1amp @ 12Volt **MAX**

-5x DC/PWM fan headers supporting up to 1amp @ 12Volt **MAX**
(selectable in BIOS, can function as DC or PWM)

Unpacking and Parts Descriptions

Equipment

The following accessories are included with the EVGA Z170 FTW Motherboard:



The EVGA Z170 FTW Motherboard

This motherboard contains the Intel Z170 chipset.



I/O Shield

Installs in the system case to block radio frequency transmissions, protect internal components from dust, foreign objects, and aids in proper airflow within the chassis.



2x SATA 3G/6G Data Cables

Used to support the SATA protocol and each one connects a single drive to the motherboard.



I/O Cover

This optional cover attaches to the PCB and covers the I/O area



2Way SLI Bridge

Link for attaching 2 cards in SLI.



Case Badge

EVGA enthusiast Case Badge



Fastener kit

Screws for mounting your I/O Cover



Installation CD

Contains drivers and software needed to setup the motherboard.



User Manual

The user manual you are reading right now!

Component Legend

Intel Z170 FTW Motherboard

The EVGA Z170 FTW Motherboard with the Intel Z170 and PCH Chipset. Figure 1 shows the motherboard and Figure 2 shows the back panel connectors

FIGURE 1. Z170 FTW Motherboard Layout

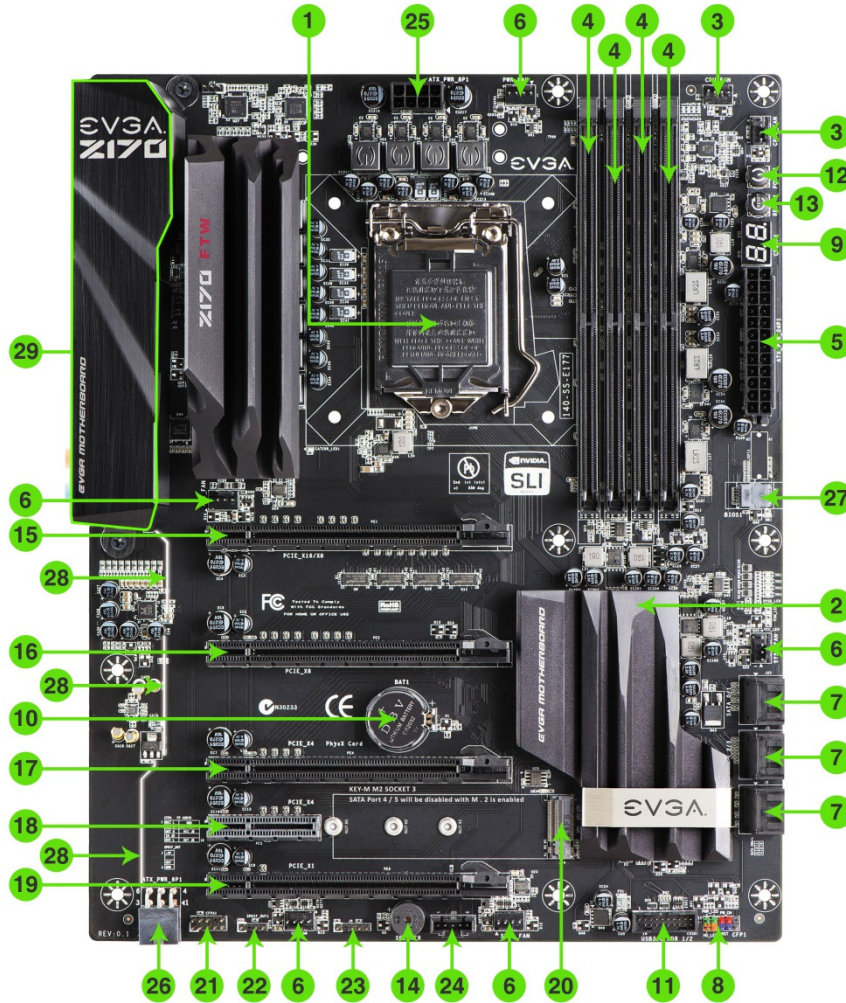

1. CPU Socket 1151	11. USB 3.0 Headers	21. Front Panel Audio Connector
2. Intel Z170 PCH	12. Power Button	22. S/PDIF Out
3. CPU Fan Header (1 amp PWM)	13. Reset Button	23. EVGauge
4. DDR4 Memory DIMM Slots 1-4	14. PC Speaker	24. Thunderbolt GPIO
5. 24-pin ATX power connector	15. PCI-E Slot x16/x8	25. 8 pin EPS Connector
6. Fan Headers (1 amp DC/PWM)	16. PCI-E Slot x8	26. Supplemental PCI-E 6pin Power
7. Intel SATA 6G Ports	17. PCI-E Slot x4 (x16 slot)	27. Removable BIOS Chip
8. Front Panel Connectors	18. PCI-E Slot x4	28. Shielded/backlit audio traces
9. Debug LED / CPU Temp Monitor	19. PCI-E Slot x1 (x16 slot)	29. Back Panel Connectors (Figure 2)
10. CMOS Battery	20. M.2 Socket 3 Key-M	

PCI-E Slot Breakdown

PCI-E Lane Distribution

- ❑ PE1 – x16/8 (x8 if PE2 is used), 16/8 lanes from CPU
 - ❑ PE2 – x8, 8 lanes form CPU
 - ❑ PE3 – x4, 4 lanes from PCH
 - ❑ PE4 – x4 4 lanes from PCH
 - ❑ PE5 – x1, 1 lane from PCH
- This motherboard does not have lane replication via PLX; all lanes are derived from CPU and PCH.

Rear I/O Panel Legend

Figure 2. Chassis Rear Panel Connectors

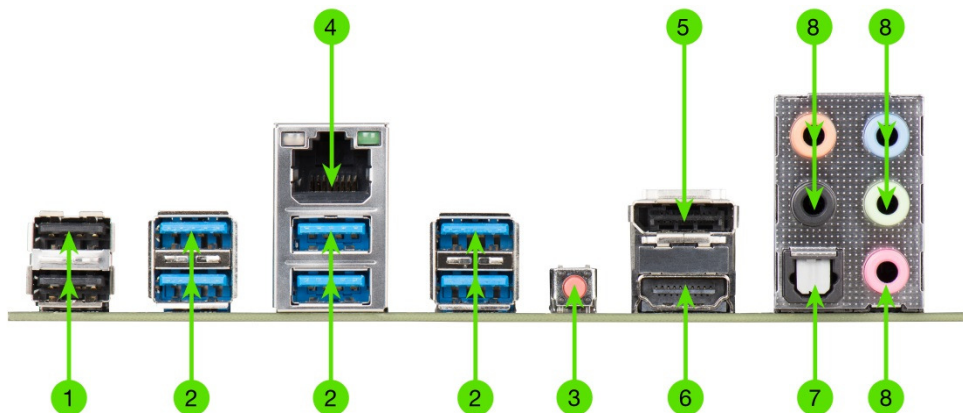

1. USB 2.0	4. Intel i219 NIC	7. Optical Out
2. USB 3.0	5. Display Port 1.2	8. Analog Audio Output Jacks
3. BIOS/CMOS Reset	6. HDMI 1.4	

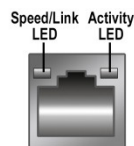

Speed/Link LED Status	Description
Orange	1000 Mbps data rate
Green	100 Mbps data rate
Off	10 Mbps data rate

Activity LED Status	Description
Off	No data transmission
Blinking (Green)	Data transmission

Analog Audio Port Breakdown	2/2.1 Channel	4.0/4.1 Channel	5.1 (6 Channel)	7.1 (8 Channel)
Blue	Line in	Line In	Line in	* Side Speaker Out
Green	Front Speaker Out/ Front Speaker + Sub	Front Speaker Out/ Front Speaker + Sub	Front Speaker Out	Front Speaker Out
Pink	Mic In	Mic In	Mic In	Mic In
Black		Rear Speaker Out	Rear Speaker Out	Rear Speaker Out
Orange			Center/Sub Out	Center/Sub Out

* Only used in 7.1 and is changed via Realtek Software from within Windows.

Preparing the Motherboard

Installing the CPU

Be very careful when handling the CPU. Hold the processor only by the edges and do not touch the bottom of the processor.

Note: Use extreme caution when working with the CPU, not to damage any pins in the CPU socket on the motherboard!



Use the following procedure to install the CPU onto the motherboard:

- ❑ Remove the plastic protective socket cover by pulling it straight up. Be sure not to damage any of the pins inside the socket.
- ❑ Unhook the socket lever by pushing down and away from the socket.
- ❑ Pull the socket lever back and the load plate will lift.
- ❑ Open the load plate and make sure not to damage any of the pins inside the socket.



Note: After removing the CPU socket cover, it is recommended to store it in case you ever need to transport your motherboard. If you ever remove the CPU, it is highly recommended to reinstall the socket cover.

- ❑ Align the notches on the CPU to the notches in the socket.
- ❑ Lower the processor straight down into the socket.



Note: Make sure the CPU is fully seated and level in the socket.

- ❑ Lower the load plate so it is resting on the CPU.
- ❑ Carefully lock the lever back into place.



Installing the CPU Cooling Device

There are many different cooling devices that can be used with this motherboard. Follow the instructions that come with your cooling assembly.

Installing System Memory (DIMMs)

Your Z170 FTW has 4 (288-pin) slots for DDR4 memory. These slots support 4GB, 8GB and 16GB DDR4 DIMMs. There must be at least one memory slot populated to ensure normal operation.

The Intel Z170 chipset supports dual channel memory recommended to be populated in pairs; supports a maximum of 64GB of DDR4 and up to 3200MHz+ in dual channel configuration. Slots 1 and 3 are the primary priority slots; slots 2 and 4 are the secondary slots. It is required to populate slot 1 first.

Use the following procedure to install DIMMs. Note that there is only one gap near the center of the DIMM slots. This slot matches the slot on the DIMM to ensure the component is installed properly.



	Channel 0		Channel 1	
	Slot1	Slot2	Slot3	Slot4
1 DIMM		●		
2 DIMM		●		●
3 DIMM	●	●		●
4 DIMM	●	●	●	●

- ❑ Unlock a DIMM slot by pressing the module clip.
- ❑ Align the memory module to the DIMM slot, and insert the module vertically into the DIMM slot, pressing straight down to seat the module. The plastic clips at top side of the DIMM slot automatically lock the DIMM into the connector.

Note: The memory controller on most Skylake CPUs runs at a default frequency of 2133MHz. To achieve memory speeds above 2133+ may require manual setting of the memory timings, frequency and voltages and/or overclocking of the CPU.

Refer to the memory manufacturer specifications for the recommended memory timings. For overclocking support you can visit our forums: <http://forums.evga.com/>

Installing the Motherboard

The sequence of installing the motherboard into a system case depends on the chassis you are using and if you are replacing an existing motherboard or working with an empty system case. Determine if it would be easier to make all the connections prior to this step or to secure the motherboard and then make all the connections. It is normally easier to secure the motherboard first.

Use the following procedure to install the I/O shield and secure the motherboard into the chassis.

Note: Be sure that the CPU fan assembly has enough clearance for the system case covers to lock into place and for the expansion cards. Also make sure the CPU Fan assembly is aligned with the vents on the covers. This will depend on the system case being used.

Installing the I/O Shield/Cover

The motherboard kit comes with an I/O shield that is used to block internal components from dust and foreign objects, and promotes correct airflow within the chassis.

Before installing the motherboard, install the I/O shield from the inside of the chassis. Press the I/O shield into place and make sure it fits securely.

Also included is an I/O cover. This I/O cover adds a unique appearance to the I/O area of the motherboard and is completely optional. If you wish to use the cover, please place it over the I/O area, and install the chassis screws. The chassis screws are intended to hold the I/O cover down.

Securing the Motherboard into a System Case

Most system cases have a base with mounting holes you thread standoffs onto to allow the motherboard to be secured to the chassis and help to prevent short circuits. If there are studs that do not align with a mounting hole on the motherboard, it is recommended that you remove that standoff to prevent the possibility of a short circuit.

- ❑ Carefully place the motherboard onto the standoffs located inside the chassis.
- ❑ Align the mounting holes with the standoffs.
- ❑ Align the connectors to the I/O shield and/or I/O cover.
- ❑ Ensure that the fan assembly is aligned with the chassis vents according to the fan assembly instruction.
- ❑ Secure the motherboard with nine (9), or ten (10) screws depending on the specific board in the series, less fasteners are needed on mATX and mITX boards, please see pic on following page for locations of all standoff locations for this board series. Ensure that each screw is lined up with and screwing into the corresponding standoff under the board. Double check alignment to make sure nothing gets cross-threaded.
- ❑ See the picture below for a zoomed in view of a hole to use a standoff in as well as the locations of standoff holes for all boards in the Z170 series.

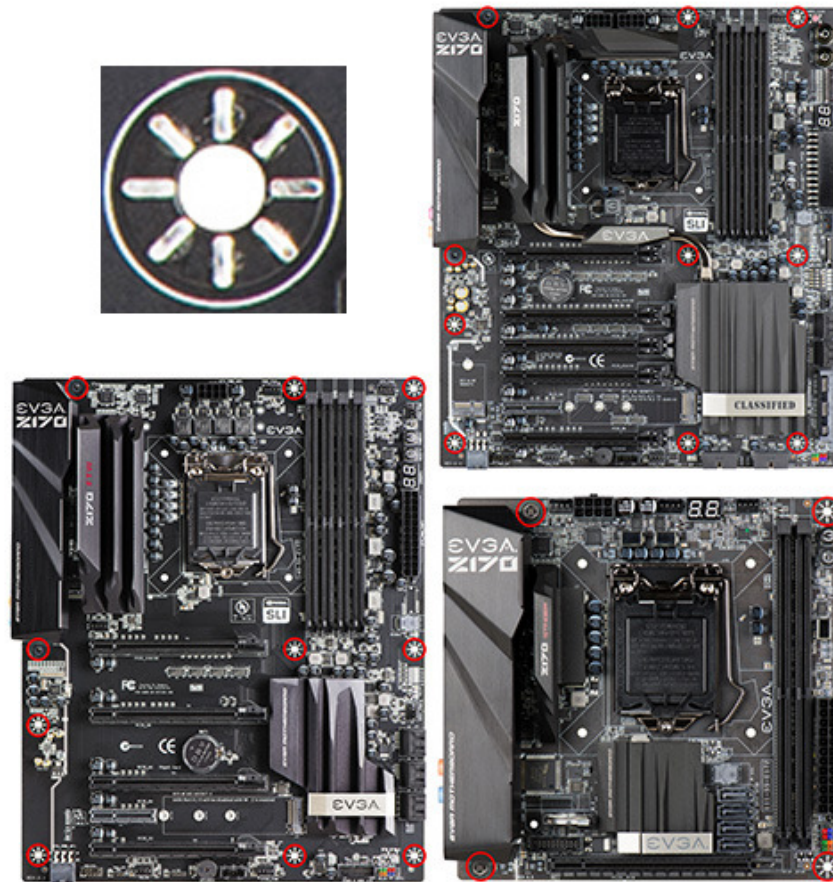

- Above, all locations safe to secure the board to a standoff with are circled in red, and the upper left side of that picture is a zoomed in view of the hole.
- Keep in mind that when the screws are installed but not fully tightened, the motherboard should have 1-2mm of movement; this can help with getting cards mounted or other tight tolerance/close fitting cards.

Connecting Cables

This section takes you through all the necessary connections on the motherboard. This will include:

- ❑ Power Connections

- 24pin ATX power (**PW1**)

- EPS 8pin 12V power

- ❑ Internal Headers

- Front Panel connectors (power/reset/LED's)

- Fan Headers (PWM for CPU and DC/PWM for case fans)

- USB 3.0 Header

- Audio Header

- S/PDIF

- Thunderbolt GPIO

- EVGauge

- ProbeIT

- SATA III

- 6pin PCIE

- ❑ Rear I/O Panel

24-pin ATX Power (ATX_PWR_24P)

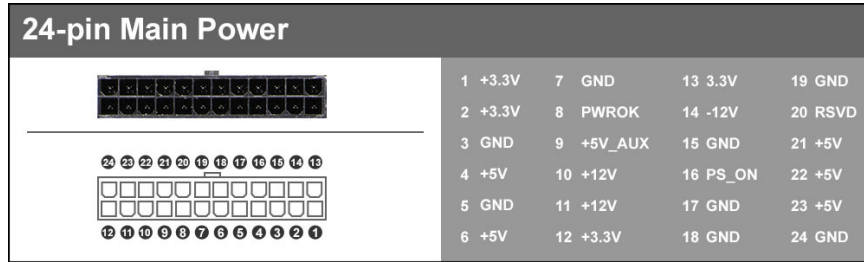

ATX_PWR_24p is the main power supply connector located along the lower right edge of the board. Make sure that the power supply cable and pins are properly aligned with the connector on the motherboard. Firmly plug the power supply cable into the connector and make sure it is secure.

The 24pin Power Connector may be standard or right angled depending on your motherboard model.

EPS 8-pin 12V Power (PWR 8P1)

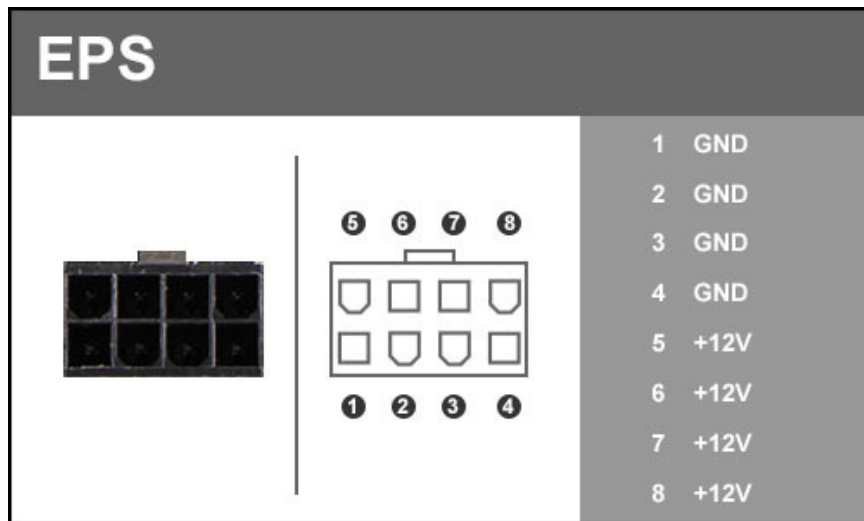

EPS PWR 8P1, the 8-pin ATX 12V power connections, is used to provide power to the CPU. Align the pins to the connector and press firmly until seated. The secondary is optional for improved overclocking. Please remember to make sure that the tab on the EPS socket is aligned with the release clip on the cable, because if they are on opposite sides, while it will be able to fit, it is the incorrect cable and WILL damage the board if powered on, as that is a PCI-E 8pin cable.

Connecting Internal Headers

Front Panel Header

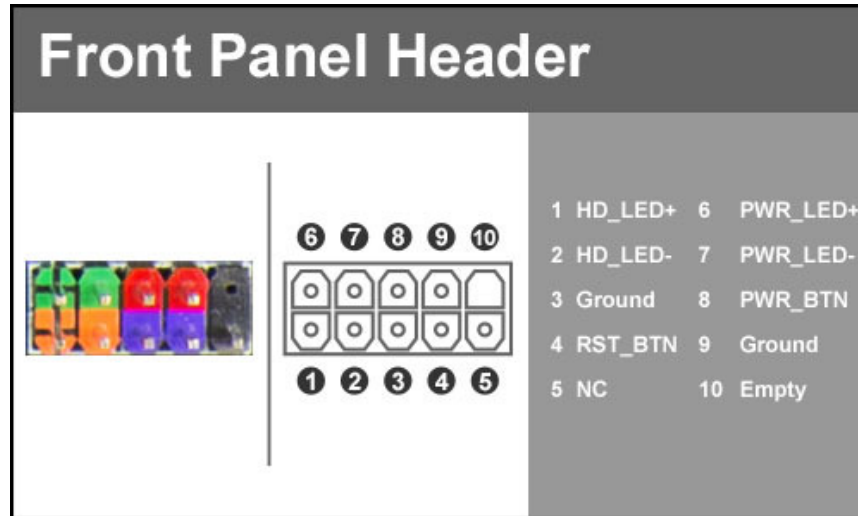

The front panel header on this motherboard is used to connect the following four cables.

❑ **PWRLED**

Attach the front panel power LED cable to these two pins of the connector. The Power LED indicates the system's status. When the system is powered on, the LED will be on.

❑ **PWRSW**

Attach the power button cable from the case to these two pins. Pressing the power button on the front panel turns the system on and off rather than using the onboard button.

❑ **HD_LED**

Attach the hard disk drive indicator LED cable to these two pins. The HDD indicator LED indicates the activity status of the hard disks.

❑ **RESET**

Attach the Reset switch cable from the front panel of the case to these two pins.

Note: Some system cases may not have all four cables. Be sure to match the name on the connectors to the corresponding pins.

Fan Header

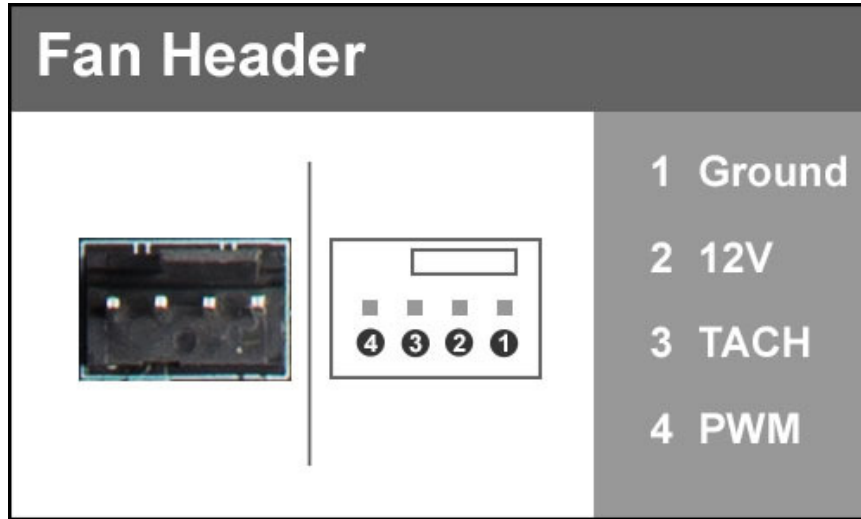

This motherboard line only has 4pin fan headers, which are backwards compatible with 3 pin, can be controlled by PWM or DC controls and has an absolute safe power limit of 1 Amp @ 12 Volts (12 Watts). These plugs are for your CPU heatsink and chassis cooling fans.

USB Headers

The motherboard has a 19-pin internal header connectors onboard that can be used to connect an optional external bracket containing up to (2) USB 3.0 ports.

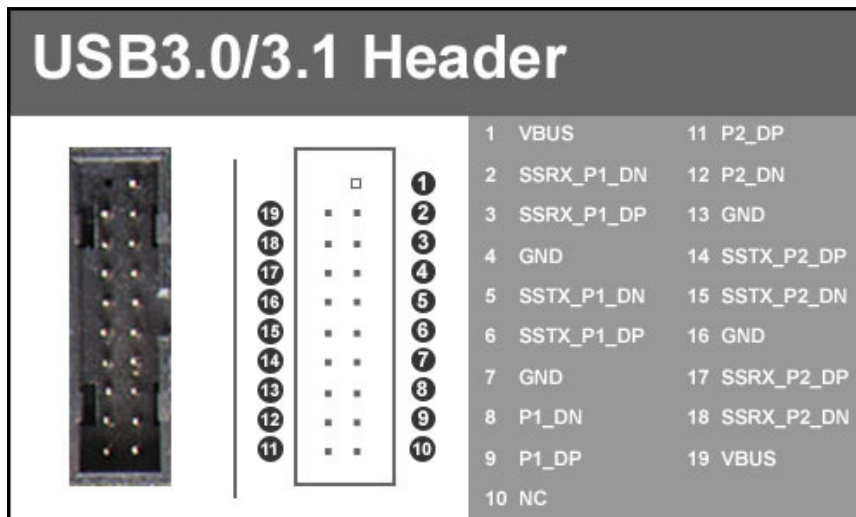

- ❑ Secure the bracket to either the front or rear panel of your chassis (not all chassis are equipped with the front panel option).
- ❑ Connect the two ends of the cables to the USB 3.0 headers on the motherboard.
- ❑ USB 3.0 and 3.1 share the same header and pinouts, physically they are the same, and the difference is the controller they are attached to. The header is labelled as a 3.0/3.1 accordingly.

Front Panel Audio

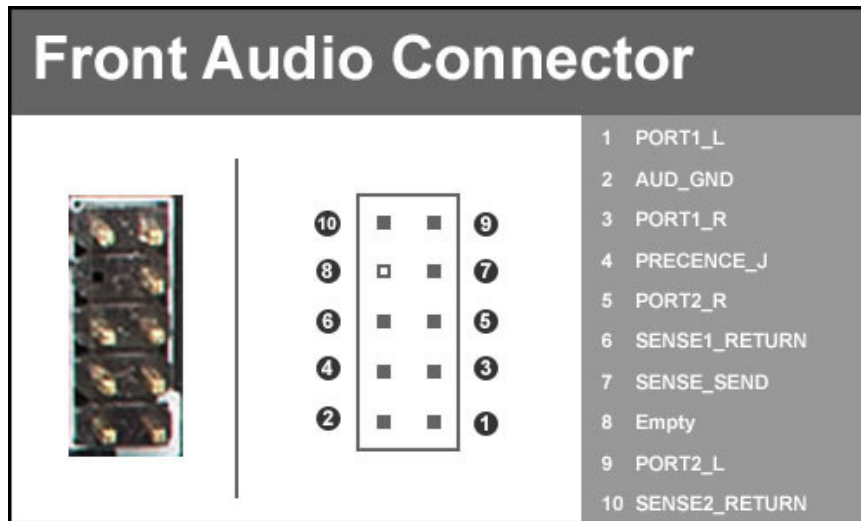

The audio connector supports HD audio standard and provides two kinds of audio output choices: the Front Audio and the Rear Audio.

S/PDIF Header

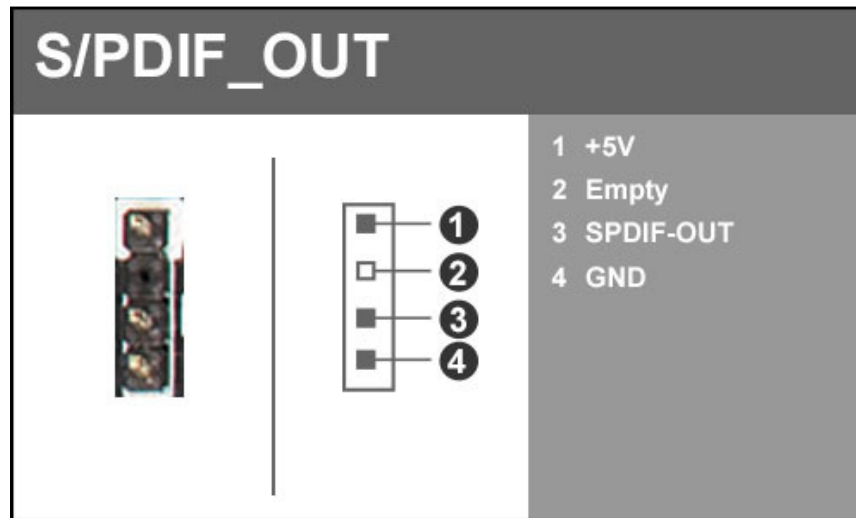

The S/PDIF (Sony/Philips Digital Interface Format) is used for specific Audio-Out applications, typically for using an audio pass-through device.

Thunderbolt GPIO

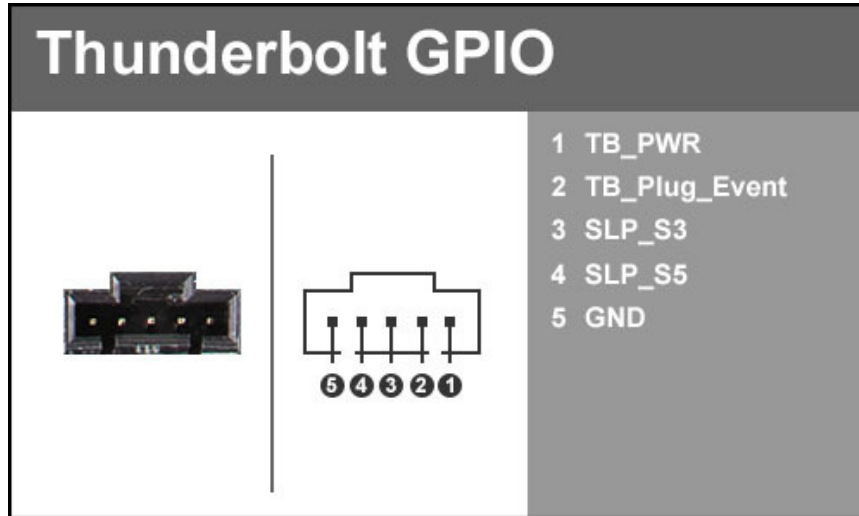

Thunderbolt technology is a transformational high-speed, dual protocol, PC I/O delivering performance, simplicity and flexibility. Thunderbolt I/O technology lets you move data between your devices and your computer with 2 channels of 20Gbps flowing both ways (upstream and downstream) at the same time. And it allows you to connect as many as 6 devices, daisy chained, through a single compact port.

EVGauge

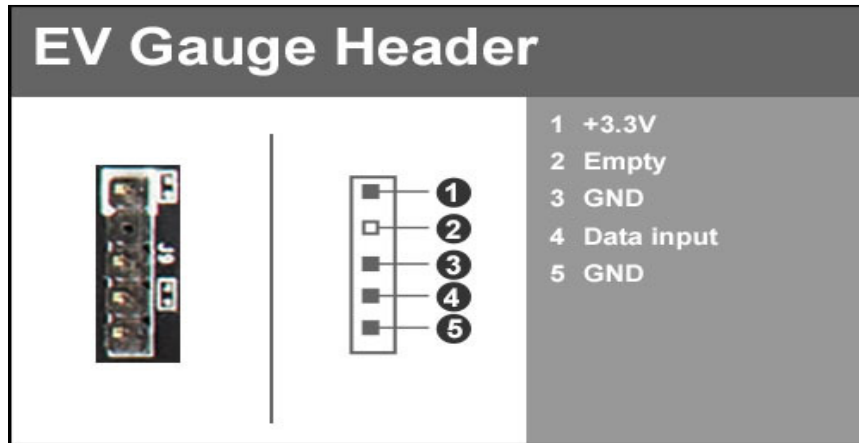

The EVGauge gives you a physical gauge to view the speed your processor is running at. This will show you live updates showing idle speeds as well as your Boost/Overclock speeds.

Probe IT

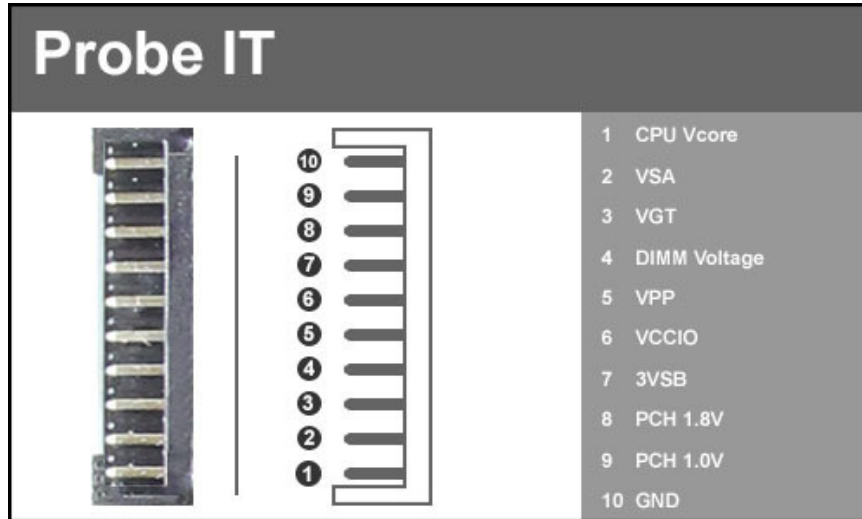

The Probe IT offers a means of monitoring several different voltages under any level of load with a digital multi-meter so you can see exactly what voltages your board is pushing, mainly used for extreme overclocking.

SATA 3/6G & SATA Express

SATA3/6G is the current standard for HDD/SSD/Optical interface. These cables are the data interconnect for the motherboard. Don't forget that these devices will still need a separate power connection.

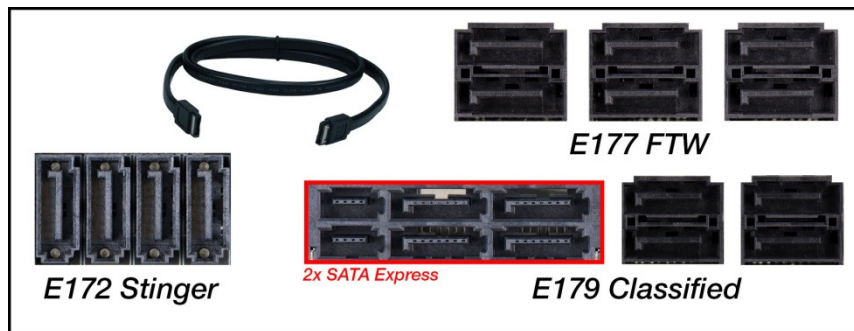

SATA Express is a significant increase over SATA3 but has a much larger connector; the internals of the connector are segmented in such a way that they will support standard SATA cables/devices at the devices native speed.

6pin PCIE

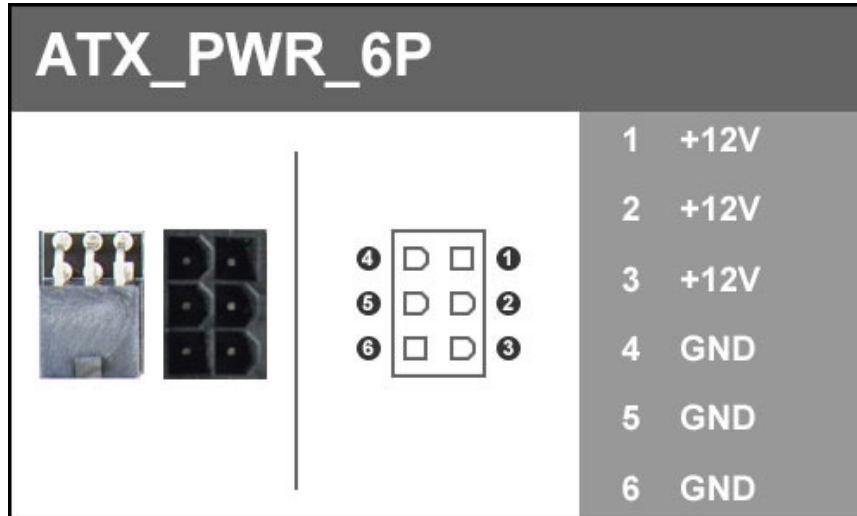

The 6pin PCIE connector present on the motherboard is there to provide additional power to the PCIE slots rather than pulling it all from the 24 pin main power. It is advised when using SLI especially with higher power draw cards, 3 and 4 way SLI it is strongly recommended to use this, regardless of GPU.

PCI-E & M.2 Slots

All of the boards in this series have at least 1 PCI-E x16 slot available, which is typically used for a video card, however if you use a CPU with onboard video you can leave it empty or place a different type of card into the slot. You will also see x4 PCIE slots as well as 2 variants of M.2



Onboard Buttons

These onboard buttons include RESET, POWER and Clear CMOS. These functions allow you to easily reset the system, turn on/off the system, or clear the CMOS.

Clear CMOS Button

The motherboard uses the CMOS RAM to store all the set parameters. The CMOS can be cleared by pressing the Clear CMOS button either onboard or on the external I/O Panel.

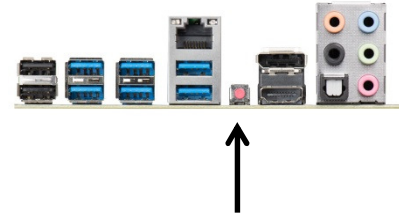

External Clear CMOS Button

RESET and POWER Button

These onboard buttons allow you to easily turn on/off the system. These buttons allow for easy debugging and testing of the system during troubleshooting situations.

The POWER button with an integrated LED indicates the system's status. When the system is powered on, the LED remains a solid red.

The RESET button with an integrated LED indicates the activity status of the hard disk drives and will flicker accordingly.



↑
Power
Button

↑
Reset
Button

Post Debug LED and LED Status Indicators

Post Port Debug LED

Provides two-digit diagnostic POST codes which shows system boot status and can also show why the system may be failing to boot. It is very useful during troubleshooting situations.

This Debug LED will display a series of hexadecimal (0-F) codes during the POST and upon a successful boot, will display current CPU socket temperatures after the system has fully booted into the Operating System. See the “POST CODE” section below for more detailed descriptions of specific POST Codes.



Debug LED with CPU
Temperature Monitor

LED Status Indicators

These LEDs indicate the system's status and are located near the 24pin connector.

❑ **POWER LED (Green):**

When the System is powered on: This LED is on.

❑ **DIMM LED (Yellow):**

When the Memory slot is functional: This LED is on.

❑ **STANDBY LED (Blue):**

When the System is in Standby Mode: This LED is on. This LED will remain on as long as the motherboard is receiving constant power.

Installing Drivers and Software

Note: It is important to remember that before installing the driver CD that is shipped in the kit, you need to load your operating system. The motherboard supports 64 bit versions of Windows 10 and 8, also 64 & 32 bit versions of Windows 7.

The kit comes with a CD that contains utilities, drivers, and additional software.

The CD that has been shipped with the EVGA Z170 Motherboard contains the following software and drivers:

- ❑ Chipset Drivers
- ❑ Audio Drivers
- ❑ RAID Drivers
- ❑ LAN Drivers
- ❑ USB 3.0 Drivers
- ❑ ME Drivers
- ❑ SATA Drivers
- ❑ EVGA E-LEET X
- ❑ User's Manual

Windows 10/8/7 Driver Installation

1. Insert the EVGA Z170 installation CD for the motherboard included in the kit.
2. The CD will autorun. Install the drivers and utilities listed on the install screen. If the CD does not run, go to My Computer and click on the CD to open.

POST Codes

This section provides the AMI POST Codes for the EVGA Z170 Dark Motherboard during system boot up.

The POST Codes are displayed on the Debug LED readout located directly onboard the motherboard.



Debug LED with CPU Temperature Monitor

This Debug LED will also display current CPU temperatures after the system has fully booted into the Operating System.

AMI POST Codes

01	Power on. Reset type detection (soft/hard).
02	AP initialization before microcode loading
03	North Bridge initialization before microcode loading
04	South Bridge initialization before microcode loading
05	OEM initialization before microcode loading
06	Microcode loading
07	AP initialization after microcode loading
08	North Bridge initialization after microcode loading
09	South Bridge initialization after microcode loading
0A	OEM initialization after microcode loading
0B	Cache initialization
0C-0D	Reserved for future AMI SEC error codes
0E	Microcode not found
0F	Microcode not loaded
10	PEI Core is started
11-14	Pre-memory CPU initialization is started
15-18	Pre-memory North Bridge initialization is started
19-1C	Pre-memory South Bridge initialization is started
1D-2A	OEM pre-memory initialization codes
2B	Memory initialization. Serial Presence Detect (SPD) data reading
2C	Memory initialization. Memory presence detection
2D	Memory initialization. Programming memory timing

	information
2E	Memory initialization. Configuring memory
2F	Memory initialization (other).
30	Reserved for ASL (see ASL Status Codes section below)
31	Memory Installed
32	CPU post-memory initialization is started
33	CPU post-memory initialization. Cache initialization
34	CPU post-memory initialization. Application Processor(s) (AP) initialization
35	CPU post-memory initialization. Boot Strap Processor (BSP) selection
36	CPU post-memory initialization. System Management Mode (SMM) initialization
37-3A	Post-Memory North Bridge initialization is started
3B-3E	Post-Memory South Bridge initialization is started
3F-4E	OEM post memory initialization codes
4F	DXE IPL is started
50	Memory initialization error. Invalid memory type or incompatible memory speed
51	Memory initialization error. SPD reading has failed
52	Memory initialization error. Invalid memory size or memory modules do not match.
53	Memory initialization error. No usable memory detected
54	Unspecified memory initialization error.
55	Memory not installed
56	Invalid CPU type or Speed
57	CPU mismatch
58	CPU self test failed or possible CPU cache error
59	CPU micro-code is not found or micro-code update is failed
5A	Internal CPU error
5B	reset PPI is not available
5C-5F	Reserved for future AMI error codes
E0	S3 Resume is started (S3 Resume PPI is called by the DXE IPL)
E1	S3 Boot Script execution
E2	Video repost
E3	OS S3 wake vector call
E4-E7	Reserved for future AMI progress codes
E8-EB	S3 Resume Failed
EC-EF	Reserved for future AMI error codes
F0	Recovery condition triggered by firmware (Auto recovery)
F1	Recovery condition triggered by user (Forced recovery)
F2	Recovery process started

F3	Recovery firmware image is found
F4	Recovery firmware image is loaded
F5-F7	Reserved for future AMI progress codes
F8	Recovery PPI is not available
F9	Recovery capsule is not found
FA	Invalid recovery capsule
FB-FF	Reserved for future AMI error codes
60	DXE Core is started
61	NVRAM initialization
62	Installation of the South Bridge Runtime Services
63-67	CPU DXE initialization is started
68	PCI host bridge initialization
69	North Bridge DXE initialization is started
6A	North Bridge DXE SMM initialization is started
6B-6F	North Bridge DXE initialization (North Bridge module specific)
70	South Bridge DXE initialization is started
71	South Bridge DXE SMM initialization is started
72	South Bridge devices initialization
73-77	South Bridge DXE Initialization (South Bridge module specific)
78	ACPI module initialization
79	CSM initialization
7A-7F	Reserved for future AMI DXE codes
80-8F	OEM DXE initialization codes
90	Boot Device Selection (BDS) phase is started
91	Driver connecting is started
92	PCI Bus initialization is started
93	PCI Bus Hot Plug Controller Initialization
94	PCI Bus Enumeration
95	PCI Bus Request Resources
96	PCI Bus Assign Resources
97	Console Output devices connect
98	Console input devices connect
99	Super IO Initialization
9A	USB initialization is started
9B	USB Reset
9C	USB Detect
9D	USB Enable
9E-9F	Reserved for future AMI codes
A0	IDE initialization is started
A1	IDE Reset
A2	IDE Detect
A3	IDE Enable
A4	SCSI initialization is started

A5	SCSI Reset
A6	SCSI Detect
A7	SCSI Enable
A8	Setup Verifying Password
A9	Start of Setup
AA	Reserved for ASL (see ASL Status Codes section below)
AB	Setup Input Wait
AC	Reserved for ASL (see ASL Status Codes section below)
AD	Ready To Boot event
AE	Legacy Boot event
AF	Exit Boot Services event
B0	CPU Memory controller configuration
B1	Runtime Set Virtual Address MAP End
B2	iMC init
B3	Memory training
B4	Memory training
B5	Memory training / timing training
B6	Memory training
B7	Memory training
B8-BF	Memory training / DRAM final configuration
C0-CF	OEM BDS initialization codes
D0	CPU initialization error
D1	North Bridge initialization error
D2	South Bridge initialization error
D3	Some of the Architectural Protocols are not available
D4	PCI resource allocation error. Out of Resources
D5	No Space for Legacy Option ROM
D6	No Console Output Devices are found
D7	No Console Input Devices are found
D8	Invalid password
D9	Error loading Boot Option (Load Image returned error)
DA	Boot Option is failed (Start Image returned error)

EVGA Glossary of Terms

AC – Alternating Current

ACPI - Advanced Configuration and Power Interface

AHCI – Advanced Host Controller Interface

AFR – Alternate Frame Rendering

APIC - Advanced Programmable Interrupt Controller

BCLK – Base Clock (or operating frequency of base system bus)

BIOS - Basic Input Output System

CMOS - Complementary Metal-Oxide Semiconductor

CPU – Central Processing Unit

DDR - Double Data Rate

DIMM - Dual In-line Memory Module

DMI – Direct Memory Interface

DRAM - Dynamic random access memory

DVI – Digital Video Interface

ELEET/ELEET X – EVGA motherboard monitoring and tuning software

GHz – Gigahertz

GPU – Graphics Processing Unit

HDD - Hard Disk Drive

HDMI - High-Definition Multimedia Interface

HDR – High Dynamic Range Lighting

HPET - High Precision Event Timer

HT – Hyper-Threading

HSF - Heat Sink Fan

I/O - Input/ Output

IEEE - Institute of Electrical and Electronics Engineers

IGP - Integrated Graphics Processors

IMC – Integrated memory controller

IRQ - Interrupt Request
JBOD - Just a Bunch of Disks
JEDEC - Joint Electron Device Engineering Council
LAN - Local Area Network
LCD - Liquid Crystal Display
LGA – Land Grid Array
LN2 – Liquid Nitrogen Cooling
MAC - Media Access Control
MCP - Media and Communications Processor
Intel ME – Intel Management Engine
MHz – Megahertz
MMIO – Memory Mapped I/O
NB - Northbridge
NCQ - Native Command Queuing
NIC - Network Interface Card
NTFS - New Technology File System
OEM - Original Equipment Manufacturer
PATA - Parallel Advanced Technology Attachment
PCB - Printed Circuit Board
PCH – Platform Controller Hub
PCI - Peripheral Component Interconnect
PCI-E - Peripheral Component Interconnect Express
PLL – Phase Locked Loop
POST – Power on Self Test
PWM – Pulse Width Modulation
QDR - Quad Data Rate
QPI – Quick Path Interconnect
RAID - Redundant Array of Inexpensive Disks
RAM – Random Access Memory
ROM – Read Only Memory
RGB - Red Green Blue

SATA - Serial Advanced Technology Attachment
SAS – Serial Attached SCSI
SB - Southbridge
SCSI - Small Computer System Interface
SFR – Split Frame Rendering
SLI - Scalable Link Interface
SPD - Serial Presence Detect
S/PDIF - Sony/Philips Digital Interconnect Format
SPP - System Platform Processors
SSD – Solid State Drive
TCP/IP - Transmission Control Protocol/Internet Protocol
USB - Universal Serial Bus
VDroop - Voltage Droop
VGA - Video Graphics Array
VREG – Voltage Regulator

Compliance Information

FCC Compliance Information

This device complies with FCC Rules Part 15. Operation is subject to the following two conditions: (1) This device may not cause harmful interference, and (2) this device must accept any interference received, including interference that may cause undesired operation. This equipment has been tested and found to comply with the limits for a Class B digital device, pursuant to Part 15 of the FCC Rules. These limits are designed to provide reasonable protection against harmful interference in a residential installation. This equipment generates, uses and can radiate radio frequency energy and, if not installed and used in accordance with the manufacturer's instructions, may cause harmful interference to radio communications. However, there is no guarantee that interference will not occur in a particular installation. If this equipment does cause harmful interference to radio or television reception, which can be determined by turning the equipment off and on, the user is encouraged to try to correct the interference by one or more of the following measures: (1) Increase the separation between the equipment and signal source, or (2) connect the equipment to an outlet on a circuit different from that to which the signal source is connected. Consult the dealer or an experienced computer technician for help. The use of shielded cables for connection of peripheral devices to the PC systems is required to ensure compliance with FCC regulations. Changes or modifications to this unit not expressly approved by the party responsible for compliance could void the user's authority to operate the equipment.

CE Compliance Information

Generic Radiation Interference Standard for Information Technology Equipment. (EN 55022: 2006, Class B), (EN 61000-3-2: 2006), (EN 61000-3-3: 1995 + A1: 2001 + A2: 2005). Warning: This is a Class B product. In a domestic environment this product may cause radio interference in which case the user may be required to take adequate measure. Generic Immunity Standard for Information Technology Equipment. (EN 55024: 1998 + A1: 2001 + A2: 2003).

Trademark & Copyright Information

2001-2014 EVGA Corp. EVGA, the EVGA logo and combinations thereof are trademarks of EVGA Corp. All brand names, company names, service marks, logos, and trademarks of the company, or its affiliates or licensors are trademarks or registered trademarks of the company or its subsidiaries, affiliates or licensors in the US and other countries. Other company, products and service names may be trademarks or service marks of others. EVGA reserves the right to terminate this license if there is a violation of its terms or default by the Original Purchaser. Upon termination, for any reason, all copies of Software and materials must be immediately returned to EVGA and the Original Purchaser shall be liable to EVGA.com CORP for any and all damages suffered as a result of the violation or default.

Legal Information

All material including but not limited to, text, data, design specifications, diagnostics, graphics, logos, reference boards, files, images, drawings, and software including this document and the software itself (together and separately) is owned, controlled by, licensed to, or used with permission by EVGA Corporation and is protected by copyright, trademark, and other intellectual property rights. All is being provided "as is", EVGA Corporation makes no warranties, whether express or implied, statutory or otherwise with respect to the materials and expressly disclaims all implied warranties of non-infringement, merchantability, and fitness for a particular purpose. In no event shall the liability of EVGA Corporation for claims arising from the use of the materials by anyone exceed the original purchase price of the materials (or replacement of the materials at EVGA Corporation's option). All information furnished is believed to be accurate and reliable. However, EVGA Corporation assumes no responsibility for the consequences of use of such information or for any infringement of patents or other rights of third parties that may result from its use, or use of the Software. No license is granted by implication or otherwise under any patent or patent rights of EVGA Corporation except as expressly provided herein. All specifications mentioned in this publication are subject to change without notice.

Ver. 2