

User Guide

**EVGA Z390 DARK**

**Specs and Initial Installation**

# Table of Contents

EVGA Z390 DARK .....	- 1 -
Specs and Initial Installation.....	- 1 -
Before You Begin... ..	- 4 -
Parts NOT in the Kit.....	- 5 -
Intentions of the Kit.....	- 5 -
Motherboard Specifications.....	- 6 -
Unpacking and Parts Descriptions.....	- 8 -
EVGA Z390 DARK Motherboard LED reference .....	- 10 -
EVGA Z390 DARK Motherboard Component Legend .....	- 14 -
PCIe Slot Breakdown .....	- 27 -
M.2 / U.2 Slot Breakdown.....	- 27 -
Preparing the Motherboard .....	- 28 -
Installing the CPU .....	- 28 -
Installing the CPU Cooling Device .....	- 29 -
Installing System Memory.....	- 30 -
Installing the I/O Shield.....	- 31 -
Installing the Motherboard.....	- 31 -
Securing the Motherboard into a System Case .....	- 32 -
Installing M.2 devices.....	- 34 -
Installing M.2 Key-M Socket 3 Devices .....	- 34 -
Tested CPU and Memory .....	- 36 -
Tested M.2 Key-M .....	- 37 -
Tested U.2.....	- 38 -
Tested M.2 Key-E.....	- 38 -
Connecting Cables.....	- 39 -

Onboard Buttons.....	- 49 -
First Boot.....	- 50 -
M.2 SSD, PCIe SSD, and NVMe SSD Installation steps .....	- 52 -
Internal RAID Controller .....	- 54 -
Fan Header DC and PWM setup .....	- 89 -
Setting Up SLI and PhysX.....	- 93 -
Creative Labs Sound Blaster Pro Studio.....	- 97 -
EVGA NU Audio .....	- 116 -
The NU Audio Control Panel .....	- 119 -
NU Audio Custom Settings: .....	- 127 -
Installing Drivers and Software .....	- 134 -
Windows 10 Driver Installation.....	- 134 -
Warranty and Overclocking.....	- 136 -
Troubleshooting .....	- 137 -
Replacing a BIOS chip .....	- 137 -
Flashing the BIOS .....	- 140 -
Flashing the BIOS Without a CPU .....	- 143 -
SSD / HDD is not detected.....	- 144 -
System does not POST, and POST code indicator reads “C” .....	- 146 -
System does not POST, and POST code indicator reads “55” .....	- 147 -
System does not POST, and POST code indicator reads “d7” .....	- 147 -
Have a question not covered above, or want some online resources? .....	- 148 -
Multifunction LED indicator .....	- 149 -
POST Beep codes .....	- 151 -
POST Port Debug LED .....	- 152 -
POST Codes .....	- 153 -
EVGA Glossary of Terms .....	- 158 -
Compliance Information .....	- 161 -

## Before You Begin...

The EVGA Z390 DARK sets the standard for motherboards based on the Intel® Z390 chipset. Much like the EVGA X299 DARK, its older brother, the Z390 DARK is designed for ultra-enthusiasts looking to pull every last ounce of performance from the new 9th Gen Intel® 8-Core CPUs. The Z390 DARK features a 17 Phase VRM design, along with two right-angle 8pin High Current connectors to provide maximum power for overclocking. Two SMT DIMMs enable high-frequency and low latency RAM overclocking. The 10-layer PCB is studded with multiple sensors to track a variety of temperatures and voltages across the board, which can be displayed on the dual-LED displays.

For its other features, the Z390 DARK contains Creative Audio with EVGA NU Audio, two Intel® Gigabit NICs, mini-Display Port, onboard power/reset/CMOS buttons, PCIe disable switches, triple BIOS support, 8 smart fan headers, and more swagger than any motherboard should have a right to wield. If you've been holding out for a serious motherboard to upgrade, the time has is at hand.

Lastly, a motherboard is only as good as its BIOS, and the EVGA Z390 DARK features EVGA's newest UEFI/BIOS GUI with a focus on overclocking and functionality in a lean, straightforward package. You won't need to be an expert to configure your motherboard, but if you are, you'll find features unavailable anywhere else.

---

## Parts NOT in the Kit

This kit contains all the hardware necessary to install and connect your new EVGA Z390 DARK Motherboard. However, it does NOT contain the following items, which must be purchased separately in order to make the system fully functional and install an Operating System:

- ❑ **Intel® Socket 1151 Processor**
- ❑ **DDR4 System Memory**
- ❑ **CPU Cooling Device**
- ❑ **PCI Express Graphics Card**
- ❑ **Power Supply**
- ❑ **Hard Drive or SSD**
- ❑ **Keyboard / Mouse**
- ❑ **Monitor**
- ❑ **(Optional) Optical Drive**

EVGA assumes you have purchased all the necessary parts needed to allow for proper system functionality. For a full list of supported CPUs on this motherboard, please visit [www.evga.com/support/motherboard](http://www.evga.com/support/motherboard)

---

## Intentions of the Kit

When replacing a different model motherboard in a PC case, you may need to reinstall your operating system, even though the current HDD/SSD may already have one installed. Keep in mind, however, you may sometimes also need to reinstall your OS after a RMA even if your motherboard remains the same due to issues that occurred prior to replacing the motherboard.

---

## Motherboard Specifications

- ❑ **Size:**
  - EATX form-factor of 11.99 inches x 10.89 inches (304.5x276.6mm)
- ❑ **Microprocessor support:**
  - Intel® Socket 1151 Processor
- ❑ **Operating Systems:**
  - Supports Windows 10 64bit
- ❑ **System Memory support:**
  - Supports Dual-Channel DDR4 up to 4600MHz+
  - Supports up to 32GB of DDR4 memory.
- ❑ **USB 2.0 Ports:**
  - 4x from Intel® Z390 PCH – 4x internal via 2 FP headers
  - Supports transfer speeds up to 480 Mbps with full backwards compatibility
- ❑ **USB 3.1 Gen1 Ports:**
  - 4x from Intel® Z390 PCH – 2x external, 2x internal via 1 FP headers
  - Supports transfer speeds up to 5Gbps with full backwards compatibility
- ❑ **USB 3.1 Gen2 Ports:**
  - 2x from ASMedia ASM3142 – 6x external (1x Type-C, 5x Type-A),
  - 1x Type-C internal with PD3.0 w/PPS and QC4.0
  - Supports transfer speeds up to 10Gbps with full backwards compatibility
  - \*Type-C may require a Type-A adapter for backwards compatibility
- ❑ **SATA Ports:**
  - Intel® Z390 PCH Controller
  - 6x SATA 3/6 Gbit/s (600 MB/s) data transfer rate
    - Support for RAID0, RAID1, RAID5, AND RAID10
    - Supports hot plug
  - ASMedia ASM1061
  - 2x SATA 3/6 Gbit/s (600 MB/s) data transfer rate -
    - No RAID or Hot-Plug Support
- ❑ **Onboard Audio:**
  - Creative Core3D Quad-Core Audio Processor (CA0132)
  - Supports 5.1 Channel audio with Optical S/PDIF Out
  - EVGA NU Audio via the FP Audio header

❑ **Onboard LAN:**

1x Intel® i219V Gigabit (10/100/1000) Ethernet PHY

1x Intel® i210AT Gigabit (10/100/1000) Ethernet MAC+PHY

Ethernet Teaming Supported

❑ **Power Functions:**

Supports ACPI (Advanced Configuration and Power Interface)

Supports S0 (normal), S3 (suspend to RAM), S4 (Suspend to disk - depends on OS), and S5 (soft - off)

❑ **PCI Express Expansion Slots:**

3x PCIe x16 slot 1x16/8\*, 1x8/4\*, 1x4\*

1x PCIe x4 slot (via PCH)

\*LANES PER SLOT CAN VARY BASED ON DEVICES INSTALLED.  
PLEASE SEE PAGE 27 FOR LANE BREAKDOWN.

❑ **PCIe 3.0 Support:**

Low power consumption and power management features

❑ **SLI and Crossfire Support:**

2-Way SLI

3-Way Crossfire

❑ **Additional Expansion Slots:**

2x M.2 Key-M 110mm slot PCIe/NVMe and Intel® Optane™

1x M.2 Key-E slot

1x U.2 slot

❑ **Single PS/2 port for keyboard or mouse**

❑ **Fan Headers:**

2x 4-pin PWM controlled headers (CPU1/CPU2)

6x 4-pin DC\PWM headers

All fans can be controlled via Smart Fan in the BIOS.

**ALL FAN HEADERS HAVE A MAXIMUM POWER LIMIT OF 2 AMP @ 12 VOLTS (24 WATTS) EXCEEDING THIS LIMIT WILL CAUSE IRREPARABLE DAMAGE TO THE BOARD.**

## Unpacking and Parts Descriptions

The following accessories are included with the EVGA Z390 DARK Motherboard:



**The EVGA Z390 Dark Motherboard**

This motherboard contains the Intel® Z390 chipset.



**I/O Shield**

Installs in the system case to block radio frequency transmissions, protect internal components from dust, foreign objects, and aids in proper airflow within the chassis.



**2x SATA 3G/6G Data Cables**

Used to support the SATA protocol and each one connects a single drive to the motherboard.



**2x Thermal Pad for M.2**

Thermal Pad for attaching an M.2 Key-M SSD.



**Baseplate Screws and Standoffs**

10 screws and standoffs to use with the provided Z390 Dark baseplate for a chassis-free operation.



**2x Probelit Connector**

Attache your DMM to the Probelit header on the Z390 Dark for real-time voltage measurements.



**2-Way SLI Bridge**

Link for attaching 2 graphics cards in SLI\*



**Benchstand with Visual Aids**

Sturdy platform for pre-testing and platform troubleshooting. Has handy printout of the Z390 Dark components, PCIe mapping and other helpful information.



**Case Badge**

EVGA enthusiast case badge\*.

\*Not compatible with GeForce RTX graphics cards

\*Included decals, labels and case badges may vary over time, and the images used are merely reflective of the decal/label/badge designs typically included. EVGA reserves the right to change, modify, or remove decals, labels, and case badges at its discretion, at any time.





**USB Flash Drive**

Contains motherboard drivers  
and user manual.



**Visual Installation Guide**

Contains helpful steps to get your  
system up and running!

\*Included decals, labels and case badges may vary over time, and the images used are merely reflective of the decal/label/badge designs typically included. EVGA reserves the right to change, modify, or remove decals, labels, and case badges at its discretion, at any time.

## EVGA Z390 DARK Motherboard LED reference

The EVGA Z390 DARK Motherboard has several LEDs indicating power, connectivity, and activity. Below is the location of the LEDs and their function.



LED Legend		
1. M.2 Key-E Enabled	12. VPLL_OC Status	23. M.2 Key-M PM1 Enabled
2. Multi-function POST indicator	13. VCCST Status	24. U.2 PU1 Status
3. Memory DIMM 2 Status	14. Power Button	25. U.2 PU1 Enabled
4. Memory DIMM 1 Status	15. Reset Button	26. PE2 Status
5. +5V Standby Power	16. BIOS 1 Active	27. PE2 Enabled
6. CATERR	17. BIOS 2 Active	28. M.2 Key-M PM2 Status
7. VCORE Status	18. BIOS 3 Active	29. M.2 Key-M PM2 Enabled
8. VDIMM Status	19. SW Slow Mode ON	30. PE3 Status
9. VSA Status	20. PE1 Status	31. PE3 Enabled
10. VCCIO Status	21. PE1 Enabled	32. PE4 Status
11. VCCPLL Status	22. M.2 Key-M PM1 Status	33. PE4 Enabled

1. M.2 Key-M Socket3 110mm (PM1)
  - a. WHITE: M.2 can be used.
2. Multifunction POST Indicator
  - a. During boot it will cycle many different hexadecimal post codes with a range of 00-FF and this indicates what aspect of the Power On Self Test (POST) is currently running.
    - i. For a list of POST Codes, please see Page 153.
  - b. This indicator can be configured in BIOS to display hardware monitoring information, such as voltage or temperature. After boot, these LEDs will show either temperature or voltage, depending on user configuration in the BIOS.
3. Memory DIMM 2 Status
  - a. WHITE: DIMM detected and present  
RED: DIMM/Memory has failed POST
4. Memory DIMM 2 Status
  - a. WHITE: DIMM detected and present
  - b. RED: DIMM/Memory has failed POST
5. +5V Standby Power
  - a. WHITE: Voltage present (Does not mean PSU is outputting in-spec, only that this specific voltage is detected)
6. CATERR - Catastrophic Error on the processor
  - a. RED: Processor error has occurred.
  - b. OFF: No error state detected in the CPU.

7. VCORE status
  - a. WHITE: Voltage present (Does not mean PSU is outputting in-spec, only that this specific voltage is detected)
8. VDIMM status
  - a. WHITE: Voltage present (Does not mean PSU is outputting in-spec, only that this specific voltage is detected)
9. VSA Status
  - a. WHITE: Voltage present (Does not mean PSU is outputting in-spec, only that this specific voltage is detected)
10. VCCIO Status
  - a. WHITE: Voltage present (Does not mean PSU is outputting in-spec, only that this specific voltage is detected)
11. VCCPL Status
  - a. WHITE: Voltage present (Does not mean PSU is outputting in-spec, only that this specific voltage is detected)
12. VPLL\_OC Status
  - a. WHITE: Voltage present (Does not mean PSU is outputting in-spec, only that this specific voltage is detected)
13. VCCST Status
  - a. WHITE: Voltage present (Does not mean PSU is outputting in-spec, only that this specific voltage is detected)
14. Power Button
  - a. RED: Motherboard is turned on and running.
15. Reset Button
  - a. WHITE: Reset button will typically flash in conjunction with HDD/SSD LED. Depending on load, the button may flash or appear solid white at times.
  - b. NVMe SSDs cannot be read for the purposes of the Reset LED.
16. BIOS1 Active LED
  - a. WHITE: Active BIOS Chip (only 1 will be lit at a time)
17. BIOS2 Active LED
  - a. WHITE: Active BIOS Chip (only 1 will be lit at a time)
18. BIOS3 Active LED
  - a. WHITE: Active BIOS Chip (only 1 will be lit at a time)
19. SW Slow Mode ON
  - a. WHITE: Slow Mode switch has been set to enabled
20. PCIe Status for PE1. The LED will remain off when this PCIe slot is disabled or unpopulated.
  - a. WHITE: PE1 slot can be used with installed CPU.

21. PCIe Enabled for PE1. The LED will remain off when this PCIe slot is disabled or unpopulated.
  - a. GREEN: PE1 device present and detected.
22. M.2 Key-M Socket3 110mm (PM1) Status LED. The LED will remain off when this PCIe slot is disabled or unpopulated.
  - a. WHITE: PM1 slot can be used with installed CPU.
23. M.2 Key-M Socket3 110mm (PM1) Enabled LED. The LED will remain off when this PCIe slot is disabled or unpopulated.
  - a. GREEN: PM1 device present and detected.
24. U.2 PU1 Status
  - a. WHITE: Port is enabled.
  - b. OFF: No device is attached/Port is disabled.
25. U.2 PU1 Enable
  - a. GREEN: Port is connected to a working device.
  - b. OFF: No device is attached/Port is disabled.
26. PCIe Status for PE2. The LED will remain off when this PCIe slot is disabled or unpopulated.
  - a. WHITE: PE2 slot can be used with installed CPU.
27. PCIe Enabled for PE2. The LED will remain off when this PCIe slot is disabled or unpopulated.
  - a. GREEN: PE2 device present and detected.
28. M.2 Key-M Socket3 110mm (PM2) Status LED. The LED will remain off when this PCIe slot is disabled or unpopulated.
  - a. WHITE: PM2 slot can be used with installed CPU.
29. M.2 Key-M Socket3 110mm (PM2) Enabled LED. The LED will remain off when this PCIe slot is disabled or unpopulated.
  - a. GREEN: PM2 device present and detected.
30. PCIe Status for PE3. The LED will remain off when this PCIe slot is disabled or unpopulated.
  - a. WHITE: PE3 slot can be used with installed CPU.
31. PCIe Enabled for PE3. The LED will remain off when this PCIe slot is disabled or unpopulated.
  - a. GREEN: PE3 device present and detected.
32. PCIe Status for PE4. The LED will remain off when this PCIe slot is disabled or unpopulated.
  - a. WHITE: PE4 slot can be used with installed CPU.
33. PCIe Enabled for PE4. The LED will remain off when this PCIe slot is disabled or unpopulated.
  - a. GREEN: PE4 device present and detected.

# EVGA Z390 DARK Motherboard Component Legend

The EVGA Z390 DARK Motherboard with the Intel® Z390 and PCH Chipset.

Figure 1 shows the motherboard and Figure 2 shows the back panel connectors

**FIGURE 1. Z390 DARK Motherboard Layout**

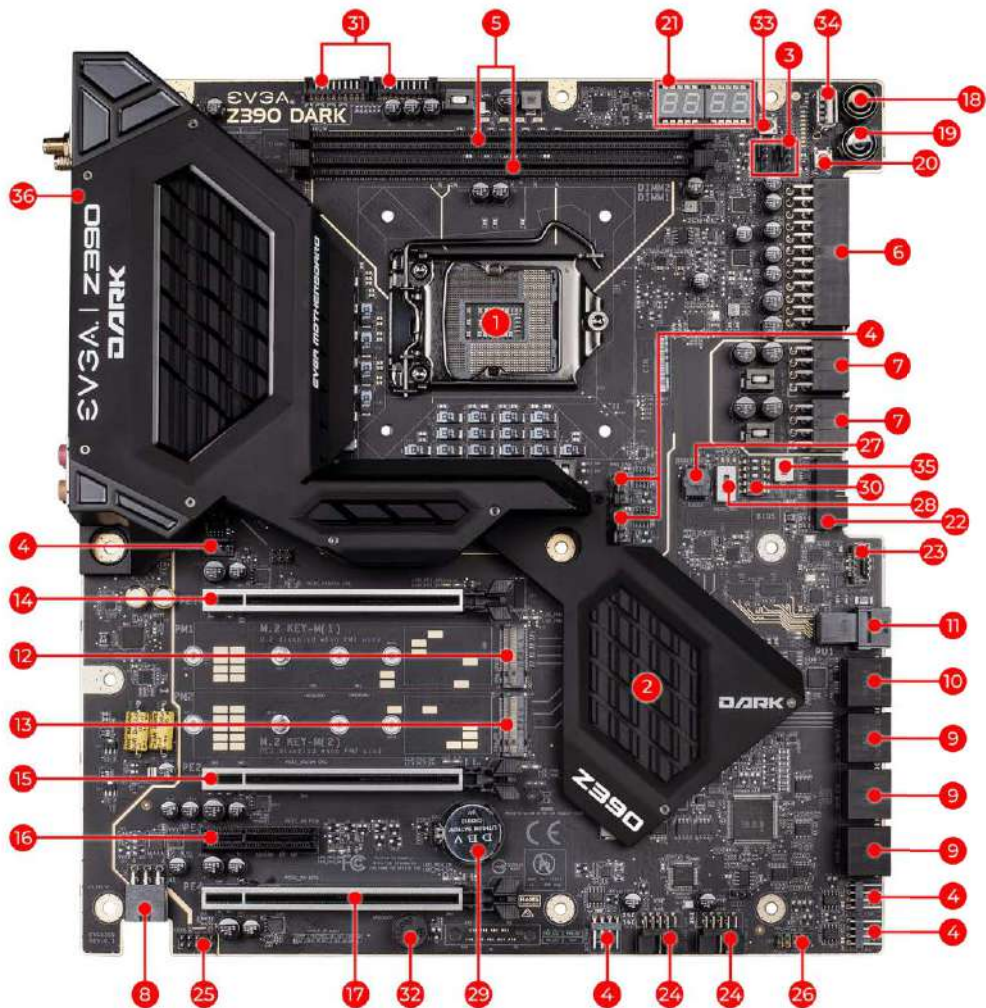

<b>Component Legend</b>		
1. CPU Socket 1151	13. M.2 Socket 3 Key-M 110mm (PM2)	25. Front Panel Audio Connector
2. Intel Z390 PCH (Southbridge)	14. PCIe Slot x16/x8	26. Front Panel Connectors
3. PWM Fan Headers (2 amp)	15. PCIe Slot x8/x4	27. Removable BIOS Chip
4. PWM/DC Fan Headers (2 amp)	16. PCIe Slot x4	28. BIOS Selector Switch
5. DDR4 Memory DIMM Slots 1, 2	17. PCIe Slot x4 (x16 Mechanical)	29. CMOS Battery
6. 24-pin ATX power connector	18. Power Button	30. PCIe Disable Switches
7. 8 pin EPS Power Connector	19. Reset Button	31. Probelit Headers
8. Supplemental PCIe 6 pin power	20. CMOS Reset Button	32. PC Speaker
9. Intel SATA 6G RAID Ports	21. Multi-function POST indicator	33. BIOS Safeboot Button
10. ASMedia SATA 6G Ports	22. USB 3.1 Gen1 Header	34. USB 2.0 to SPI for BIOS Flash
11. U.2 (SFF-8639) Port	23. USB 3.1 Gen2 Type-C Header	35. SW Slow Switch
12. M.2 Socket 3 Key-M 110mm (PM2)	24. USB 2.0 Headers	36. Rear Panel I/O (Figure 2)

\*\*For a FULL description of the above legend, please see Page 17.

**Figure 2. Chassis Rear Panel Connectors**

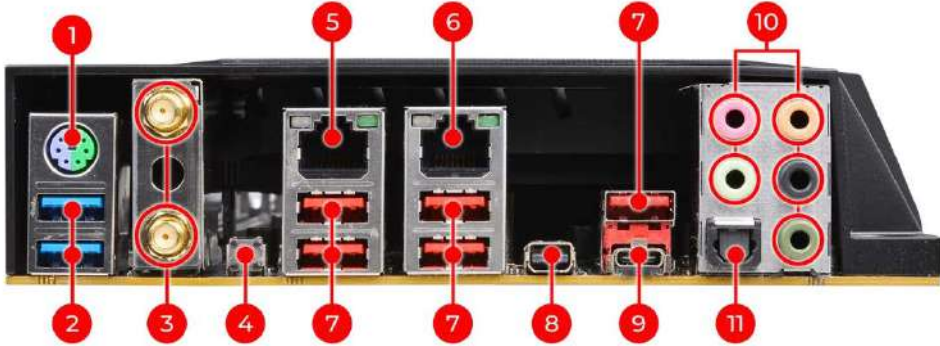

I/O Hub		
1. PS/2 (Keyboard or Mouse)	5. Intel i210V NIC	9. USB 3.1 Gen2 Type-C
2. USB 3.1 Gen1	6. Intel i219AT NIC	10. Analog Audio Jacks
3. Intel 9560 WiFi/BT	7. USB 3.1 Gen2 Type-A	11. Optical Out
4. BIOS/CMOS Reset	8. Mini-DisplayPort 1.2	



Speed/Link LED Status	Description
Orange	1000 Mbps data rate
Green	100 Mbps data rate
Off	10 Mbps data rate

Activity LED Status	Description
Off	No data transmission
Blinking (Green)	Data transmission

Analog Audio Port Breakdown	2/2.1 Channel	4.0/4.1 Channel	5.1 Channel
Dark Green	Head Phone	Head Phone	Head Phone
Light Green	Front Speaker / Speaker+Sub Out	Front Speaker/ Speaker+Sub Out	Front Speaker/ Speaker+Sub Out
Pink	Mic / Line In	Mic / Line In	Mic / Line In
Black		Rear Speaker Out	Rear Speaker Out
Orange			Center/Voice channel



## Component Legend Descriptions

### 1. CPU Socket 1151

This is the interface for the Central Processing Unit (CPU), and supports 8<sup>th</sup> and 9<sup>th</sup> Gen. Intel Core i3, i5, i7 and i9 models compatible with the Intel® LGA1151 Socket, based on Coffee Lake-S architecture. Intel® Xeon® E processors are not supported.

### 2. Intel® Z390 PCH (Southbridge)

The Platform Controller Hub (PCH) handles the role that was previously held by the South Bridge. The PCH allocates bandwidth to smaller PCIe slots, M.2, USB, audio, etc. In simplified terms, the PCH works as a hub for peripherals that are less bandwidth-intensive.

### 3. PWM Fan Headers

4-pin fan headers that control the fan speed based on a configurable curve or static percentage. PWM (Pulse-Width Modulation) works by pulsing power to the fan at a constant rate and sending the RPM signal to the fan's controller via a Sense cable, rather than adjusting fan speed by increasing and decreasing voltage. This method is preferable because it eliminates voltage-based fan stall points. Please see Page 89 for more in-depth PWM breakdown and PWM controls within BIOS/UEFI. These fans can be controlled via Smart Fan or manually within the BIOS.

### 4. DC/PWM Fan Headers

These ports may be used with both DC and PWM fans, and may be controlled via Smart Fan or manually within the BIOS.

### 5. DDR4 Memory Slots

The memory slots support up to two 288-pin DDR4 DIMMs in Dual-Channel mode. Dual-Channel mode will be enabled only upon using two or four sticks of supported memory, according to the installation guide above; using one or three sticks of memory will lower the board to Single-Channel mode, which may significantly lower performance. 32GB of RAM is supported in a 2x16GB configuration; 32GB modules are \*NOT\* officially supported. At the time of this manual's release, this motherboard officially supports up to 4600MHz+ speeds. These speeds cannot be guaranteed, however, because Intel® only certifies the speed of the memory controller up to 2666MHz for Coffee Lake-S processors.

#### 6. 24-pin ATX power connector

The main power for the motherboard is located on the right side of the board and parallel to the PCB; this is also described as a “90 degree / right-angle” connector (See Page 40 for more specifics to the connector itself, and associated wiring/pinouts). The 24-pin connector IS directional and the connector needs the tab on the socket to line up with the release clip located on the 24-pin connector from the power supply. This connector pulls the bulk of the power for all components; other connectors, such as CPU +12V EPS, PCIe (video card AND motherboard sides), have been added to reduce the load and increase longevity due to wiring and trace limitations.

#### 7. Dual 8-pin EPS Connector

The +12V EPS are comprised of 90 degree right-angle dual-dedicated power inputs for the CPU (See Page 41 for more specifics to the connector itself, and associated wiring/pinouts). Carefully choose the correct power cable by consulting with the installation manual for your power supply. This connector is designed only to work with an EPS or CPU cable. System builders may make the mistake of plugging in a PCIe 8-pin or 6+2-pin connector, which will prevent the board from POSTing and possibly short or damage the board. Although the cables appear similar, they are wired differently and attaching a PCIe cable to an EPS connector may cause damage to the motherboard.

Alternatively, if no power cable is connected or detected, the system will not POST and will hang at POST code “C.”

#### 8. Supplemental PCIe 6-pin Power Connector

There is a 6-pin PCIe connector at the bottom of the motherboard (See Page 40 for more specifics to the connector itself, and associated wiring/pinouts). This connector provides dedicated power to the PCIe x16 slots, augmenting the +12V power provided by the 24-pin and the GPU directly.

This is optional for a single card solution, but is recommended for SLI, CFX, and dual-processor video cards.

#### 9. Intel® SATA 6Gbit/s Ports

The Intel® Z390 PCH has a 6-port SATA 3/6 Gbit/s controller (See Page 48 for specifics on the connectors). This controller is backwards compatible with SATA and SATA II devices, and supports SSDs, HDDs and various types of optical devices (CDROM, DVDROM, BD-ROM, etc). The controller also

supports NCQ, TRIM, hot swap capability (provided the proper HDD/SSD bays/racks are installed), and RAID levels 0/1/5/10.

#### 10. ASMedia SATA 6Gbit/s Ports

This is a secondary SATA controller, the ASM1061 is a 2-port SATA3/6 Gbit/s controller with legacy support for older operating systems. This is included largely for benchmarking and overclocking with very specific programs, such as Super Pi, 3DMark, PCMark, etc. This board is not guaranteed to fully support any OS prior to Windows 10 x64, as we offer no drivers for legacy OS (See Page 48 for specifics on the connectors).

#### 11. U.2 Port (SFF-8639)

U.2, originally known as SFF-8639, is a high bandwidth connection specifically engineered for next generation SSDs. U.2 brings PCIe x4 (Gen3) NVMe performance to a 2.5" SSD form factor and provides a solution to potential heating problems that may be present in some M.2 solutions. Port function depends on installed CPU-type and BIOS Configuration.

#### 12. M.2 Socket 3 Key-M 110mm (PM1)

M.2 is an SSD form factor standard, which uses up to four PCIe lanes and utilizes Gen3 speeds. Most popularly paired with NVMe SSDs, this standard offers substantially faster transfer speeds and seek time than SATA interface standards. All M.2 devices are designed to connect via a card-bus style connector and be bolted into place and powered by the connector, rather than by a dedicated data cable and power cable.

This socket will support Key-M devices of 110mm, 80mm, 60mm, and 42mm length.

This connector can utilize only PCIe/NVMe-based M.2 SSDs, or Intel® Optane™ NVMe devices.

#### 13. M.2 Socket 3 Key-M 110mm (PM2)

M.2 is an SSD form factor standard, which uses up to four PCIe lanes and utilizes Gen3 speeds. Most popularly paired with NVMe SSDs, this standard offers substantially faster transfer speeds and seek time than SATA interface standards. All M.2 devices are designed to connect via a card-bus style connector and be bolted into place and powered by the connector, rather than by a dedicated data cable and power cable.

This socket will support Key-M devices of 110mm, 80mm, 60mm, and 42mm length.

This connector can utilize only PCIe/NVMe-based M.2 SSDs, SATA M.2, or Intel® Optane™ NVMe devices.

#### 14. PCIe Slot x16/x8\*

PCIe x16/x8 slots are primarily used for video cards. These full-length slots will provide 8 or 16 lanes of bandwidth to a full-size card, and are backwards-compatible with x8, x4, and x1-length cards.

Coffee Lake-S has 16 PCIe lanes available for routing.

#### 15. PCIe Slot x8/4\*

PCIe x8/4 slot can be used for video cards or other devices. PE2, the only x8/x4 slot on the board, receives either x8 lanes or x4 from the CPU (Page 27), depending upon the peripheral configuration. These full-length slots will provide up to 8 lanes of bandwidth to a full-size card, and are backwards-compatible with x8, x4, and x1-length cards.

Coffee Lake-S has 16 PCIe lanes available for routing.

#### 16. PCIe Slot x4\*

PCIe x4 slot PE3 uses up to 4 Gen 3 lanes from the PCH. This slot is typically used for sound cards, WiFi, USB, LAN or other peripheral cards. Using this slot will have no effect on the bandwidth or throughput of the x16 slots used for SLI because this slot uses only PCH bandwidth.

#### 17. PCIe Slot x4\* (x16 Mechanical)

PCIe x4 slot can be used for video cards or other devices. PE4, the only full x16 mechanical slot that runs at x4 electrically, receives either x4 lanes or x0 from the CPU (Page 27), depending upon the peripheral configuration. These full-length slots will provide up to 4 lanes of bandwidth to a full-size card, and are backwards-compatible with x1-length cards.

PCIe x4 slot PE4 uses up to 4 Gen 3 lanes from the CPU. This slot shares 4 lanes with PE2, and will change both PE2 and PE4 to x4 lanes. Using this slot will disable SLI because SLI requires at least 2 slots capable of x8 bandwidth.

Coffee Lake-S has 16 PCIe lanes available for routing.

#### 18. Power Button

This is an onboard power button, and may be used in place of, or in conjunction with, a front panel power button wired to the board.

Benching systems, or test benches before final assembly, are best served by using the onboard power because it removes the need to wire a Power/Reset

button or cross posts with a screwdriver, which is a semi-common practice. This button provides a safer and easier option than jumpering the Power posts.

#### 19. Reset Button

This is an onboard system reset button, and may be used in place of, or in conjunction with, a front panel system reset button wired to the board.

Benching systems, or test benches before final assembly, are best served by using the onboard power because it removes the need to wire a Power/Reset button or cross posts with a screwdriver, which is a semi-common practice.

This button provides a safer and easier option than jumpering the Power posts.

#### 20. CMOS Reset Button

This button has two main uses: the first is standard practice to clear BIOS and power on before updating the BIOS, and the second is standard practice when troubleshooting instances when the motherboard fails to POST, such as after upgrading RAM or CPU, installing new hardware, a failed overclock, etc. This button provides a much faster means of resetting than the previous method of removing power from the board, removing the CMOS battery, and discharging power to the board. In rare occasions the older method can help; pressing the clear CMOS button will normally allow you and your system back into the default BIOS.

#### 21. Debug POST Indicator / Hardware Monitor

This is a four-digit POST code reader, which displays in sets of 7-digit LED. The display can be configured to show data in regular decimal format, or hexadecimal, which means the characters available (when working as intended) are 0-9, A-F and has a cap of 255 characters.

During POST, the left set of LEDs will display the various POST codes as they cycle through the Power On Self-Test. The POST codes are listed in the troubleshooting section on Page 153.

After the system boots, these same set of LEDs can be set to display a hardware monitoring sensor, such as the CPU temperature in Celsius. This temperature is specifically for the CPU socket, which will typically read slightly higher than a given CPU core. To read this temp in Fahrenheit, take the value in Celsius, multiply by 9/5 (or 1.8) and add 32.

The display can be used to show additional temperatures, or can be configured in tandem with all 4 digits to provide live readings for voltages or temperatures. For example, the LEDs can be configured to read voltages, such as 1.258 or -

55C for CPU temp for when you are using LN2 extreme cooling. Detailed configuration instructions for the Debug Indicator are provided on Page 149.

## 22. USB 3.1 Gen1 Header

The USB 3.1 Gen1 header is used to connect additional USB interface plugs to the motherboard; these headers are most often used to connect the motherboard to the chassis to enable the USB 3.1 Gen1 ports on the chassis. These will function similarly to the USB 3.1 Gen1 ports found on the motherboard's rear I/O hub, but can also be used for the chassis' front panel USB, auxiliary ports that mount in the card slots, and certain devices that directly connect to the header.

USB 3.1 Gen1 standard is 900ma @ 5V for unpowered devices. If your USB device requires more power, it is recommended to attach a powered USB Hub.

USB 3.1 Gen2 Type-A (found on the I/O Hub) shares the power limit of USB 3.1 Gen1 at 900ma @ 5V.

Note: USB 3.1 Gen1 is more commonly referred to as USB 3.0.

## 23. USB 3.1 Gen2 Header (Type-C)

The USB 3.1 Gen2 header is used to connect additional USB interface plugs to the motherboard; these headers are most often used to connect the motherboard to the chassis to enable the USB 3.1 Gen2 ports on the chassis. These will function similarly to the USB 3.1 Gen2 Type-C port sometimes found on a motherboard's rear I/O hub, but can also be used for the chassis' front panel USB, auxiliary ports that mount in the card slots, and certain devices that directly connect to the header. The USB 3.1 Gen2 Header on the Z390 DARK is a shielded USB 3.1 Gen2 Header and supports up to 10Gb/s with USB 3.1 Gen2.

This USB 3.1 Gen2 Header has a power limit of 3000ma (3A) @ 5V.

## 24. USB 2.0 Headers

The USB2.0 header is used to connect additional USB interface plugs to the motherboard; these headers are most often used to connect the motherboard to the chassis to enable the USB2.0 ports on the chassis. These will function the same as the USB2 ports found on the motherboard's hardwired I/O hub, but these can be used to attach to front panel USB, auxiliary ports that mount in the card slots, and also some devices that directly connect to the header.

USB 2.0 standard is 500mA @ 5V per port (header total is 1000mA) for unpowered devices. If your USB device requires more power than this, it is recommended to attach a powered USB Hub.

## 25. Front Panel Audio Connector

This is a motherboard header, which is used to plug in the audio cable originating from most PC chassis to allow audio to be recorded from or played through the audio connectors on the chassis. This header has a connector that looks similar to USB2 and will use the standard “HD Audio” jack. Some systems may have two headers: one labeled HD Audio, and one labeled AC’97 – an AC’97 cable is **not** compatible with this header on the Z390 DARK.

## 26. Front Panel Connectors

The Front panel connectors are the four main chassis connections. These include the Power Switch, Power LED, Reset Switch, and HDD LED. The Power and Reset switches are both designed to use “Momentary Switches,” rather than “Latching Switches,” which means the connection between the two posts needs to be made just briefly for it to work, as opposed to being held in place. This is why the Power and Reset switches can be triggered with a screw driver by simultaneously touching the + and - posts.

Power LED will power on with the system, indicating the system is on and can blink with CPU activity.

HDD LED will blink during access to the SATA ports; this is not activated for M.2 SSDs.

## 27. Removable BIOS1 Chip

The ability to remove and replace the BIOS1 chip without requiring special tools is a key feature on many of our boards, by adding a level of protection against BIOS failures, bad BIOS flashes, BIOS corruption, etc. This feature also allows EVGA to work with end-users if something happens to render the BIOS chip unusable or a BIOS update is needed for CPU compatibility; rather than replacing the whole board, Customer Support can send a pre-flashed BIOS chip to get you up and running without requiring the end-user to send in the motherboard. Please see the walkthrough on Page 137 for further information.

## 28. BIOS Selector Switch

This switch toggles between physical BIOS chips. This board has 2 BIOS chips as a permanent fixture, and the other is a replaceable chip listed above. Each chip holds only the settings and profiles that have been saved to the BIOS chip while active. This allows you to swap between three physically different BIOS chips. This also makes it substantially easier to hotflash a BIOS if needed. If instructions are needed for hotflashing a BIOS, please contact EVGA Customer Service (Page 148 for contact info).

### 29. CMOS Battery

The +3V CMOS battery backup provides uninterruptable power to the BIOS/UEFI to keep all of the settings; otherwise, each boot would behave like you just reset the BIOS. These batteries typically last several years and rarely need to be replaced.

### 30. PCIe Disable Switches

These are DIP switches to physically disable power to a specific PCIe slot. By default, all switches are in the “On” position to the left. Move the switch to the right to disable a specific slot. From top to bottom, the switches correspond to PE1, PE2, and PE4. PE3 is always on. Switches 4 and 5 are disabled.

### 31. ProbeIt Header

The ProbeIt header is a means of live monitoring several different system voltages in real-time with a multimeter. One terminal needs to connect to a ground wire and the other to the specific you are trying to monitor. There are two ProbeIt connectors: the left connector is J3, and the right connector is J5.

From left to right the function for the J3 connector: VCORE/Ground, VDIMM/Ground, VGT/Ground, VSA/Ground, and VCCIO/Ground.

From left to right the function for the J5 connector: VCCPLL/Ground, VCCPLL\_OC/Ground, VCCST/Ground, PCH/Ground, and DMI/Ground.

### 32. PC Speaker

This is a small mono low-fidelity speaker permanently attached to the motherboard used mainly for debugging purposes. A POST beep may indicate a successful POST, various tones for USB initialization, and other beeps to indicate an issue during the post process. Please see Page 151 for more details.

### 33. BIOS SafeBoot Button

Pressing this button while the system is running will reboot the motherboard directly into the BIOS without clearing CMOS. This feature is very useful for situations where the motherboard is unable to complete boot due to a failed overclock and the user does not want to erase the previous settings used.

### 34. USB to SPI for BIOS Flash

This USB port is designed to connect directly to the motherboard to allow the motherboard BIOS to be flashed, even if no CPU is installed. For more information on how to flash your BIOS using this method, please see Page 140.



### 35. SW Slow Mode Switch

This switch forces the CPU clock ratio to the lowest possible value (8.0 for Coffee Lake-S CPU) in real-time. This can be helpful for benchmarking and performance tuning, especially with extreme overclocking. Active Slow Mode is indicated by a red LED near the switch. This is a hardware-based function and does not need any BIOS settings or software to operate.

### 36. Rear Panel IO (Figure 2)

This is the section referred to as the I/O Hub. This panel contains the hardwired USB, Sound, and Ethernet connections. Please see Page 16 for a component level breakdown.

\* There are two numeric references for PCI Express: one is mechanical, which is the actual slot-length footprint, and the second is electrical, which is a reference of how many PCIe lanes are routed to the slot.

As PCI Express is designed to be a universal architecture, you can install x1 cards, such as sound cards or USB controllers into an x16 slot. Many types of cards can use different amounts of PCIe lanes, while some applications use only certain parts of a card, such as compute apps that allow a card to run off of a single PCIe lane. This is why there are x16 mechanical slots with an x1 electrical PCIe lane. Using the entire length of a PCIe slot is unnecessary, nor does it cause an adverse effect to use a shorter form-factor bus card in a slot that physically can hold a larger form-factor bus card.

## Card Slots

The Z390 DARK features three x16 PCIe slots, one x4 PCIe slot, two Socket 3 Key-M M.2 110mm slots (PM1/PM2) (backwards compatible with Key-M 80mm, 60mm, and 42mm), and vertical Socket 1 Key-E M.2 (Contains the WiFi module).

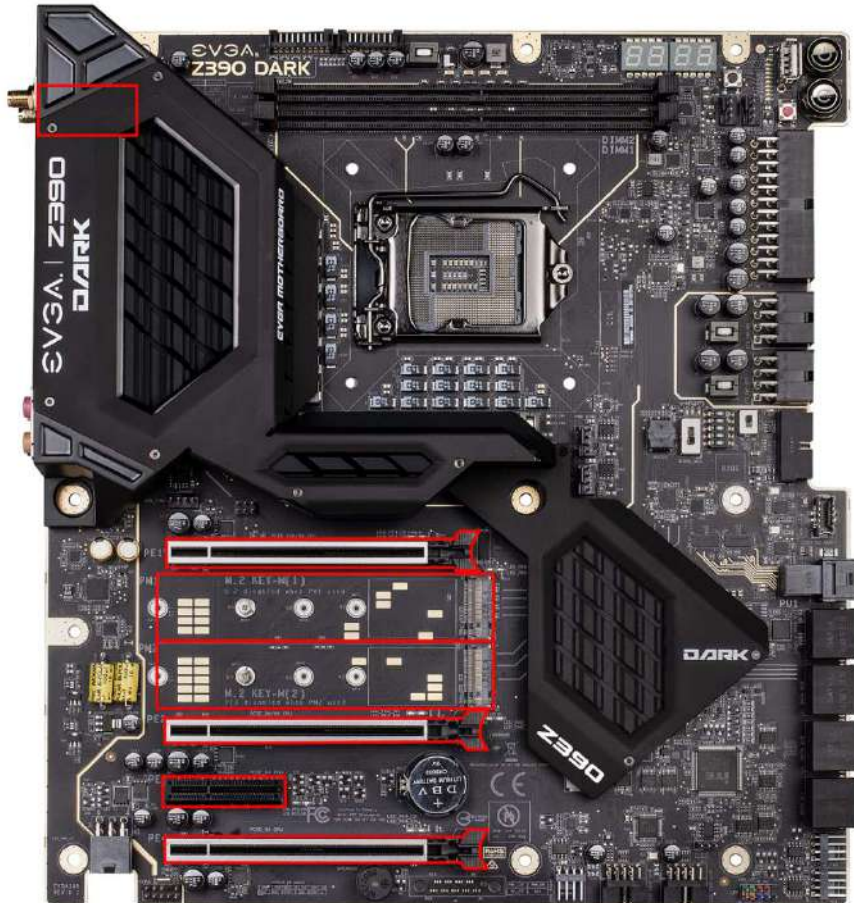

\*Note: The M.2 Key-E 32mm slot is accessible only after removing the cover over the rear panel connectors.

---

## PCIe Slot Breakdown

### PCIe Lane Distribution (All Socket 1151 processors are 16 lanes.)

- ❑ PE1 – x16 (Gen3, x16 lanes from CPU, x8 shared with PE2)
- ❑ PE2 – x8 (Gen3, x8 lanes from CPU, x4 shared with PE4)
- ❑ PE3 – x4 (Gen3, x4 lanes from PCH)
- ❑ PE4 – x4 (Gen3, x4 lanes from CPU, shares 4 of PE2's 8 lanes)

---

## M.2 / U.2 Slot Breakdown

### M.2 Lane Distribution

- ❑ M.2 Key-M (110mm, Top, PM1) – x4 from Z390 PCH
  - M.2 Enable/Disable is set within the BIOS
  - This M.2 Key-M slot shares lanes with the U.2 port. Installing an M.2 device will disable U.2 port PU1.
- ❑ M.2 Key-M (110mm, Bottom, PM2) – x4 from Z390 PCH
  - M.2 Enable/Disable is set within the BIOS
  - This M.2 Key-M slot shares lanes with PE3. Installing an M.2 device will disable PCIe slot PE3.
- ❑ M.2 Key-E (32mm) – x1 from Z390 PCH
  - M.2 Enable/Disable is set within the BIOS

### U.2 Lane Distribution

- ❑ U.2 (PU1) – x4 from Z390 PCH
  - U.2 Enable/Disable is set within the BIOS
  - This U.2 port shares lanes with the M.2 Key-M slot PM1. Installing a U.2 device will disable PM1.

## Preparing the Motherboard

### Installing the CPU

**Note:** EVGA strongly recommends that you completely disconnect AC power from your power supply prior to changing your CPU. This ensures the motherboard will use the correct startup procedure for all onboard devices. If AC power is not disconnected, the replacement is still supported, but may require additional reboots to boot successfully.

Be very careful when handling the CPU. Hold the processor only by the edges and do not touch the bottom of the processor.

**Note:** Use extreme caution when working with the CPU to avoid damaging the pins in the motherboard's CPU socket!

Do not remove the socket cover until you have installed the CPU. This installation guide was created without using a socket cover to better illustrate the CPU Socket area. However, users should remove the cover as the **last step**, not the first step.

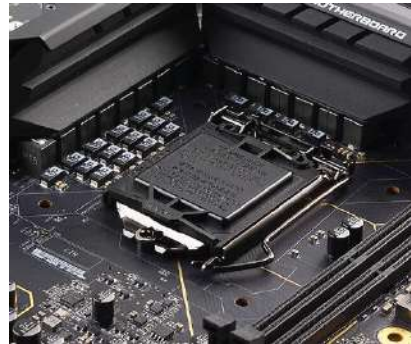

Use the following procedure to install the CPU onto the motherboard.

1. Unhook the socket lever by pushing down and towards the socket.
2. Pull the socket levers back and gently lift the load plate to open the socket. Make sure to avoid touching or dropping items into the socket; otherwise, you may damage the board socket and/or CPU pins, which may void your warranty.



- Align the notches on the CPU to the notches in the socket, and lower the processor straight down into the socket.

**Note:** The gold triangle key on the CPU should match the triangle key on the load plate.

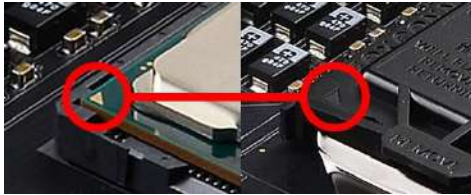

**Note:** Make sure the CPU is fully seated and level in the socket.

- Lower the load plate so that it is resting on the CPU.
- Carefully lock the lever back into place by lowering it down to the hook, then push the lever towards the socket and down under the hook.
- Remove the plastic protective socket cover by pulling it straight up and away from the socket.



**Note:** After removing the CPU socket cover, it is recommended to store it in case you ever need to transport your motherboard. If you ever remove the CPU, it is highly recommended to reinstall the socket cover.

## Installing the CPU Cooling Device

There are many different cooling devices that can be used with this motherboard. Follow the instructions that come with your cooling assembly.

## Installing System Memory

Your Z390 DARK has (2) 288-pin slots for DDR4 memory. These slots support 4GB, 8GB and 16GB DDR4 Unbuffered non-ECC DIMMs. There must be at least one memory slot populated for the board to boot and operate.

The Z390 DARK supports Dual-Channel DDR4 memory, a maximum of 32GB and up to 4600MHz+ (OC) for Coffee Lake-S. It is recommended to always use a 2 DIMM Dual Channel kit for the Z390 DARK.

Fill the memory slots in the following order: 1, then 2. See chart to the right:

Use the following procedure to install memory DIMMs. Note that there is a key notch near the center of the DIMM slots. This matches the gap on a DDR4 DIMM to ensure the memory is installed properly, and to prevent the incorrect installation of memory.

1. Unlock a DIMM slot by pressing the module clips outward.
2. Align the memory module to the DIMM slot, insert the module vertically into the slot, and press straight down to fully seat the module. The plastic clips at top side of the DIMM slot should automatically lock the DIMM into the connector.

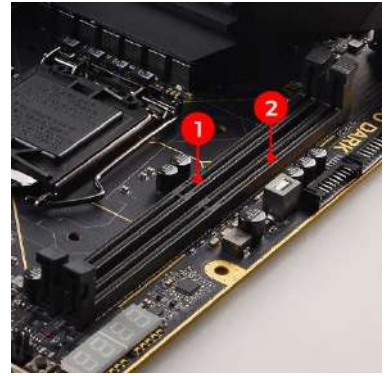

Coffee Lake-S RAM Slot Fill Order		
	Slot 1	Slot 2
1 DIMM	X	N/A
2 DIMM	X	X

**Note:** The memory controllers on Coffee Lake-S CPUs run at a default frequency of 2667MHz. Achieving memory speeds above 2667MHz may require using the XMP profile or manual setting of the memory timings, frequency and voltages. Using an XMP profile for speeds over 2667MHz is considered overclocking.

Refer to the memory manufacturer specifications for the recommended memory timings and settings.

---

## Installing the I/O Shield

The motherboard kit comes with an I/O shield that is used to block internal components from dust and foreign objects, while also promoting correct airflow within the chassis.

Before installing the motherboard, install the I/O shield from the inside of the chassis. Press the I/O shield into place and make sure it fits securely.

## Installing the Motherboard

Installing the motherboard into a system case depends on several factors: whether you are replacing an existing motherboard, whether you are building a new PC, and the type of chassis that will house your PC components. You must first determine if it would be easier to secure the motherboard to the chassis or if it would be easier to install other components prior to this step. It is normally easier to secure the motherboard first.

---

**Note:** Make sure that the CPU fan assembly has enough clearance for your installed DIMMs, expansion cards, and for the case side panels to lock into place. Also, make sure the CPU fan assembly aligns with the vents on the case side and back panels; correctly aligned, airflow will properly exhaust from the chassis. The CPU fan assembly orientation will depend upon both the CPU fan manufacturer's instructions and your chosen chassis.

---

---

## Securing the Motherboard into a System Case

Most system cases require installation of standoffs into the chassis to allow the motherboard to be mounted to the chassis and prevent short circuits. If there are any studs that do not align with a motherboard mounting hole, we recommend that you remove that standoff to prevent the possibility of a short circuit. Furthermore, ensure that all standoffs are fully tightened prior to mounting the motherboard to the chassis. Please review the installation manual included with your chassis for the proper installation of the motherboard standoffs.

1. Carefully place the motherboard onto the standoffs located inside the chassis.
2. Align the mounting holes with the standoffs.
3. Align the connectors to the I/O shield and/or I/O cover.
4. Ensure that the fan assembly aligns with the chassis vents according to the fan assembly instruction.
5. Secure the motherboard with ten (10) screws (See next page for mount hole location). Ensure that each screw is lined up with and fastened to its corresponding standoff under the board. Double-check alignment to make sure nothing gets cross-threaded.

Tip: If you have difficulty fastening some of the screws, especially near the I/O hub, first try to loosely fasten all other screws on the motherboard, but don't completely tighten the screws. This may help to hold the board in place, allowing you to thread and fasten the remaining screws. Once all screws are properly threaded, remember to go back and tighten the rest of the screws.

6. See the picture below for a zoomed-in view of a hole to place over a standoff, as well as the locations of standoff holes for the Z390 DARK.



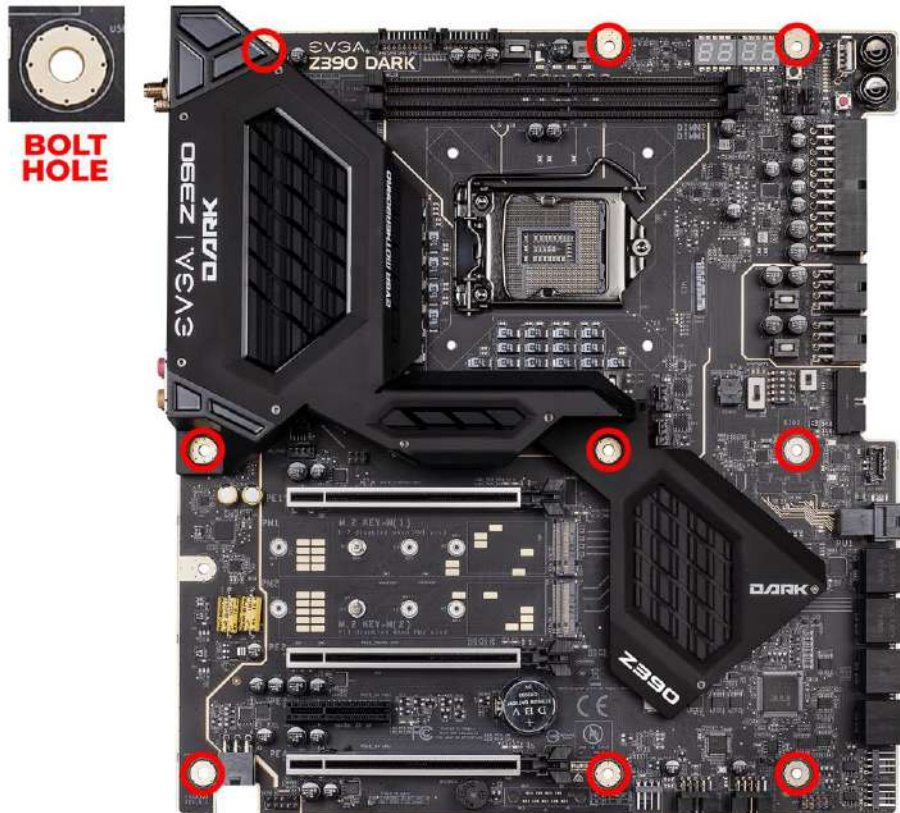

1. All safe locations to secure the board to a standoff are circled in white.
2. Keep in mind that when the screws are installed, but not fully tightened, the motherboard should have 1-2mm of movement; this can help when mounting cards or tight-fits with other components.
3. Once the board is properly aligned, be sure to fully-tighten the board to the chassis before proceeding.

# Installing M.2 devices

## Installing M.2 Key-M Socket 3 Devices

Securing an M.2 device to the motherboard requires a few extra steps compared to other current drive or slot-based connectors. M.2 devices used on this motherboard - Socket 3 (for SSDs) and Socket 1 (for WiFi/Bluetooth) – are installed differently.

Below are images from an installation of an SSD on the Socket 3 Key-M 80mm slot of the Z390 DARK.

1. Before you can install an M.2 device, you must first remove the screw that comes pre-attached to the Socket 3's retention standoff; this will be used to keep the device in place. The standoff is placed at the 80mm interval for the Socket 3 slot. There are also additional standoffs available for different size drives, such as 110mm Intel 905P Optane SSDs.

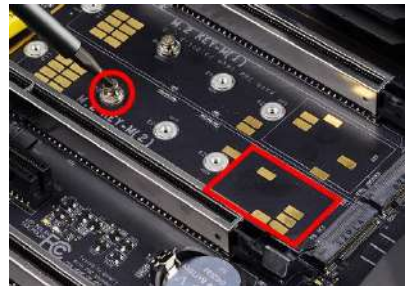

Next add one thermal pad – included with the Z390 DARK accessories – to the outlined area to the right.

2. After adding the thermal pad, the motherboard will look like the image below. This thermal pad will assist with cooling your M.2 Key-M device.



3. Insert the M.2 device at a slight angle of approximately 45 degrees to the board. This will allow the contacts (colloquially called “Gold Fingers”) to seat completely into the slot. If the device is fully seated, you should be able to release it and the device will rest at an angle of about 30 degrees on its own, as shown in the picture to the right.

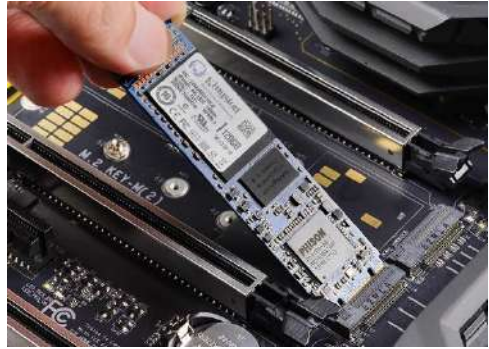

4. Gently push the M.2 device down on the raised end. There will be some tension - this is normal - then use the screw you removed in Step 1 to secure the device. At right, you can see that the contacts will be nearly invisible when the device is properly seated and the copper mounting semi-circle is partially visible around the screw.



#### Incorrect installation Example:

**\*NOTE\* This is one of the most common examples of an incorrect installation of an M.2 device. Do not intentionally attempt this, or complete your installation with this example. Doing so could cause damage to the device or the M.2 port.**

Using the image below, notice how the gold fingers fail to fully seat in the M.2 slot. This often occurs if the drive was pushed into the slot from a nearly parallel starting position, rather than an angle, causing the M.2 device to not seat fully. As a result, this may cause a drive detection failure by the BIOS, the drive will be detected with the description in gibberish (e.g. characters in the name, such as @, #, \$, %, \*, etc.) and/or notifications that the drive has corrupt data stored on it.

Moreover, if the device’s connection looks like this, then screwing down the device may be impossible (a VERY tight fit, at best), which is another sign that the device is not seated properly.

In conclusion, if the install device looks similar to the image below, please remove and reseat it using the instructions above. **DO NOT POWER THE SYSTEM ON IF THE CONNECTOR RESEMBLES THIS PICTURE.**



For further M.2 setup instructions, please see Page 52.

## Tested CPU and Memory

CPU	Core Count	Frequency	PCI-E Lanes
Coffee Lake-S			
Core™ i9-9900K	8 Cores + HT	3.60 GHz	16
Core™ i7-9700K	8 Cores	3.60 GHz	16
Core™ i5-9600K	6 Cores	3.70 GHz	16
Core™ i7-8086K	6 Cores + HT	4.00 GHz	16
Core™ i7-8700K	6 Cores + HT	3.70 GHz	16
Core™ i7-8700	6 Cores + HT	3.20 GHz	16
Core™ i7-8700T	6 Cores + HT	2.40 GHz	16
Core™ i5-8600K	6 Cores	3.60 GHz	16
Core™ i5-8600	6 Cores	3.10 GHz	16
Core™ i5-8600T	6 Cores	2.30 GHz	16
Core™ i5-8500	6 Cores	3.00 GHz	16
Core™ i5-8500T	6 Cores	2.10 GHz	16
Core™ i5-8400T	6 Cores	1.70 GHz	16
Core™ i3-8350K	4 Cores	4.00 GHz	16
Core™ i3-8100	4 Cores	3.60 GHz	16

## Tested M.2 Key-M

<b>PCI-E INTERFACE</b>	
ADATA	ASX800NP-256GM-C 256G M.2 PCIE
Samsung	MZ-V7E250 970 EVO
Samsung	MZ-V7P512 970 PRO
Samsung	MZ-VKV512 950 PRO
Samsung	MZ-V6P512 960 PRO
Samsung	MZ-VPV2560 256G SM951 NVME
Samsung	MZ-HPU128T/004 128G XP941
Samsung	MZ-HPV1280 128G SM951
Samsung	MZ-V6E250 250G 960EVO
Samsung	MZ-VPW2560 256G SM961
Samsung	MZ-VLW2560 256G PM961
Samsung	MZ-VLB2560 256G PM981
INTEL	600P SERIES SSDPEKKW512G7 M.2 512G PCIE
INTEL	600P SERIES SSDPEKKW256G7 M.2 256G PCIE
INTEL	760P SERIES SSDPEKKW010TB M.2 1TB PCIE
Kingston	SKC1000240G
Kingston	SHPM2280P2H/240G
PLEXTOR	PX-128M8PeG M.2 128G PCIE
TOSHIBA	THNSN5256GPU7 M.2 256G PCIE
WD	PC SN520 SDAPNUW-512G-1006 512G NVME M2
WD	PC SN700 WDS100T2X0C-00L350 1T NVME M2
CORSAIR	MP500 CSSD-F240GBMP500 240G PCIE3.0 NVME M2

---

## Tested U.2

U.2 (SSD):			
Brand	Part Number	Size	Interface
Intel	750 SSDPE2MW400G4	400GB	U.2 NVME w\Cable
Intel	750 SSDPE2MW400G4	400GB	U.2 NVME w\Cable

---

## Tested M.2 Key-E

<b>M.2 Key-E WIFI</b>	
INTEL	8260NGW
INTEL	9260NGW
INTEL	9560NGW
AzureWave	AW-NB165NF
Killer	1550
Killer	1550i

---

## Connecting Cables

**Note:** the following images do not necessarily represent the physical orientation of their respective headers on the EVGA Z390 DARK. Rather, these graphical representations are designed to provide a basic physical footprint and the cable pinouts for each component.

**The locations of these components can be found in the Component Legend on Pages 14-15.**

This section takes you through all the necessary connections on the motherboard. This will include:

❑ Power Connections

24pin ATX power (PW1)

EPS 8-pin 12V power

6-pin PCIe power

❑ Internal Headers

Front Panel connectors (Power/Reset/LEDs)

Fan Headers (PWM for CPU and PWM/DC for case fans )

USB 2.0 Header

USB 3.1 Gen1 Header

USB 3.1 Gen2 Type-C Header

USB to SPI Header (for flashing BIOS)

Audio Header

SATA

U.2

❑ Rear I/O Panel

## 24pin ATX Power (ATX\_PWR\_24P)

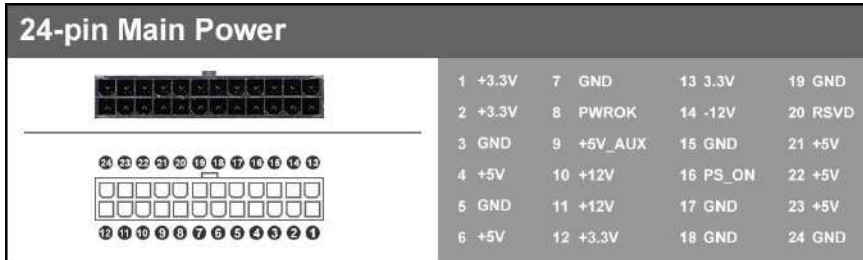

ATX\_PWR\_24p is the main power supply connector located along the lower-right edge of the board. Make sure that the power supply cable and pins are properly aligned with the connector on the motherboard. Firmly plug the power supply cable into the connector and make sure it is secure.

The 24-pin Power Connector may be standard or right-angled depending on your motherboard model. The Z390 DARK motherboard uses a right-angle 24pin ATX connector.

## 6-pin PCIe

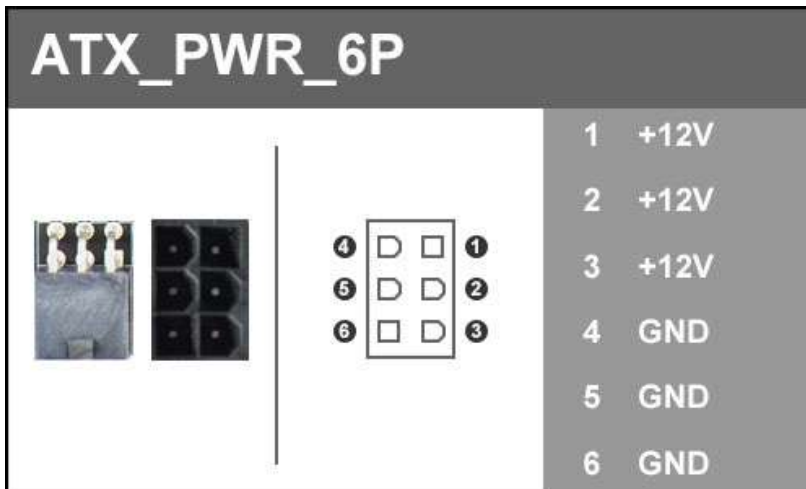

The 6-pin PCIe connector present on the motherboard provides additional power to the PCIe slots, rather than pulling it all from the 24-pin main power. It is advised to plug in this connector when using SLI, especially with higher-end graphic cards. It is strongly recommended to plug in this connector for 3-way and 4-way SLI, regardless of GPU.



## EPS 8-pin 12V Power (PWR 8P)

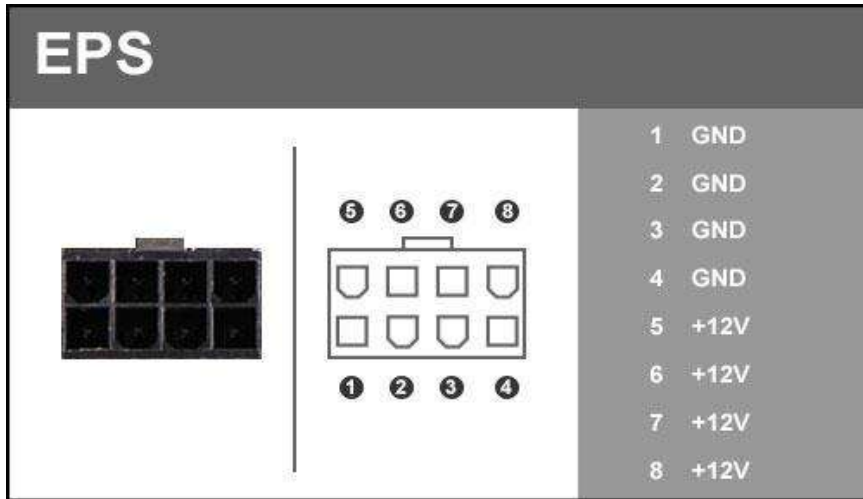

EPS PWR 8P, the 8-pin ATX 12V power connection(s), is used to provide power to the CPU. Align the pins to the connector and press firmly until seated. The secondary EPS, if present, is optional for improved overclocking. Please remember to make sure that the tab on the EPS socket is aligned with the release clip on the cable. **NOTE:** If the tab and release clip are on opposite sides, yet the power connector fits, then you are using a PCIe 8-pin cable, which **WILL** damage the board if powered on. Please review installation instructions from your power supply manufacturer to verify which connectors may be used for the CPU power.

## Front Panel Header

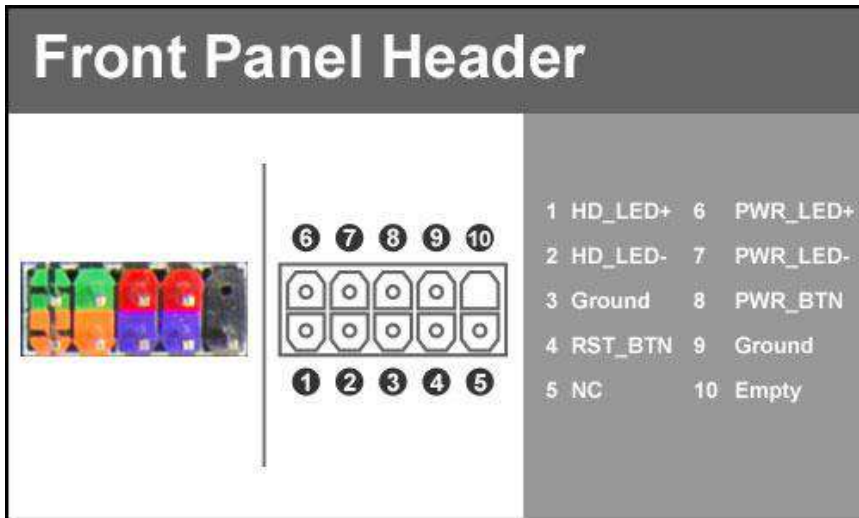

The front panel header on this motherboard is used to connect the following four cables:

- ❑ **PWRLED**  
Attach the front panel power LED cable to these two pins of the connector. The Power LED indicates the system's status. When the system is powered on, the LED will be on.
- ❑ **PWRSW**  
Attach the power button cable from the case to these two pins. Pressing the power button on the front panel turns the system on and off rather than using the onboard button.
- ❑ **HD\_LED**  
Attach the hard disk drive indicator LED cable to these two pins. The HDD indicator LED indicates the activity status of the hard disks.
- ❑ **RESET**  
Attach the Reset switch cable from the front panel of the case to these two pins.

**Note:** Some system cases may not have all four cables. Be sure to match the name on the connectors to the corresponding pins.

## Fan Header

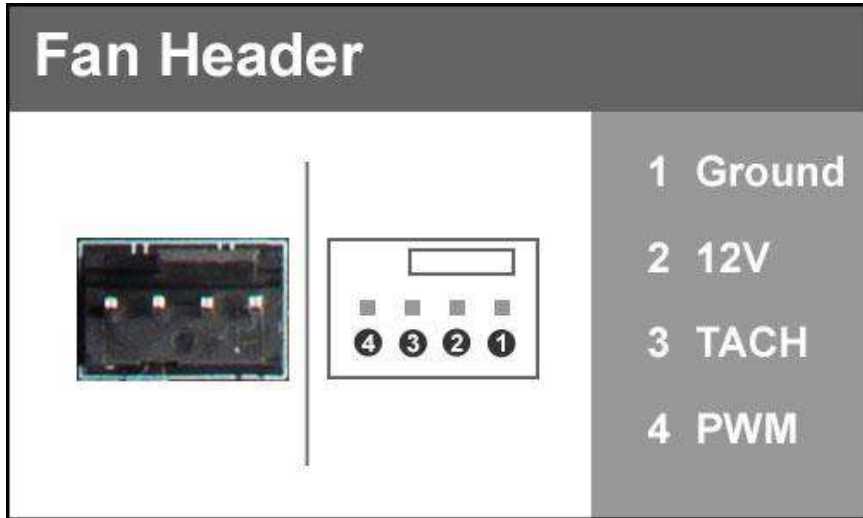

This motherboard line only has 4-pin fan headers, which are backwards compatible with 3-pin fan connectors. CPU1 and CPU2 controls fans via PWM. The remaining headers control fans by either PWM or DC controls. The headers have an absolute safe power limit of 2 Amp @ 12 Volts (24 Watts). These headers are for your CPU heatsink and chassis cooling fans.

## USB Headers

This motherboard contains USB 3.1 and 3.0 ports that are exposed on the rear panel of the chassis.

The Z390 DARK contains 1x 20pin internal header, which can support 1 USB3.1 Type-C front-panel connector or device.

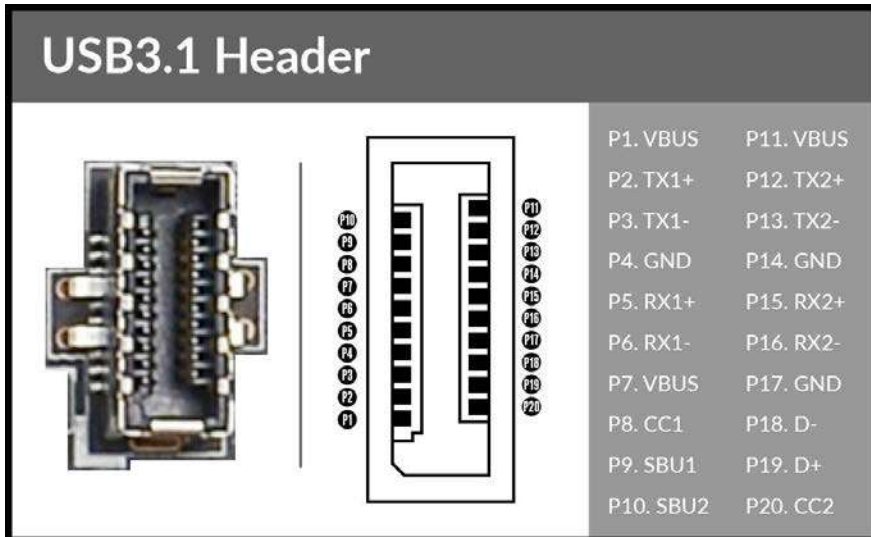

The motherboard contains 1x 19-pin internal header connectors onboard that can be used to connect an optional external bracket or device containing up to two (2) USB 3.1 Gen1 ports.

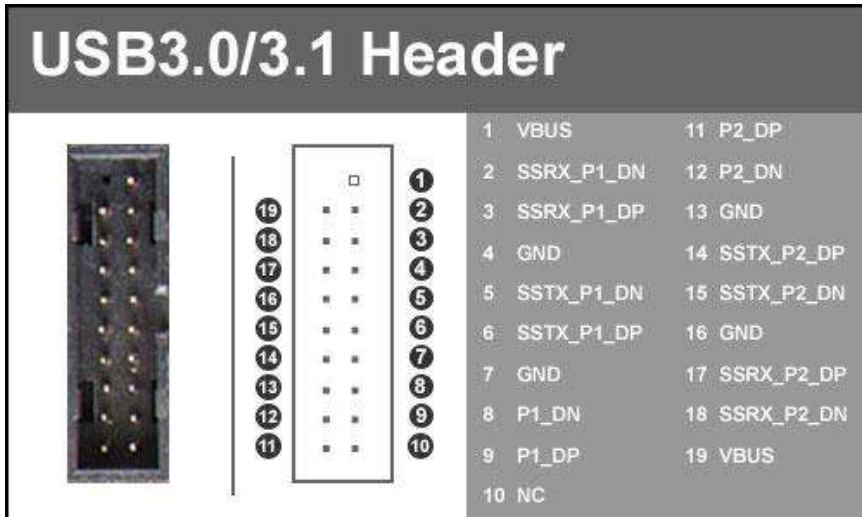

- ❑ Please note that these headers are often referred to as USB 3.0 internal headers, but the correct designation is USB 3.1 Gen 1.0.
- ❑ Secure the bracket to either the front or rear panel of your chassis (not all chassis are equipped with the front panel option).
- ❑ Connect the end(s) of the cables to the USB 3.1 Gen 1 headers on the motherboard.

The motherboard contains 2x 9-pin internal header connectors onboard that can be used to connect an optional external bracket or devices containing up to four (4) USB 2.0 ports.

## USB 2.0 Header

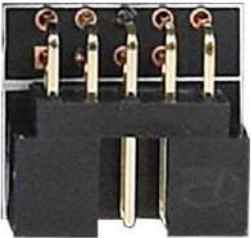

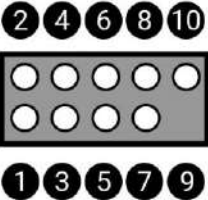

Pin	Signal
1	5V_Dual
3	D-
5	D+
7	GND
9	Empty
2	5V_Dual
4	D-
6	D+
8	GND
10	No Connect

The Z390 DARK also features an onboard USB 2.0 port header, near the power/reset buttons. This header has a specific purpose – to allow you to flash the BIOS without an installed CPU using the included USB flash drive. For more information on flashing the BIOS without a CPU, please see Page 143.

## USB to SPI BIOS Flash



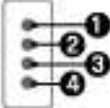

1. VCC
2. DATA -
3. DATA +
4. GND

## Front Panel Audio Header

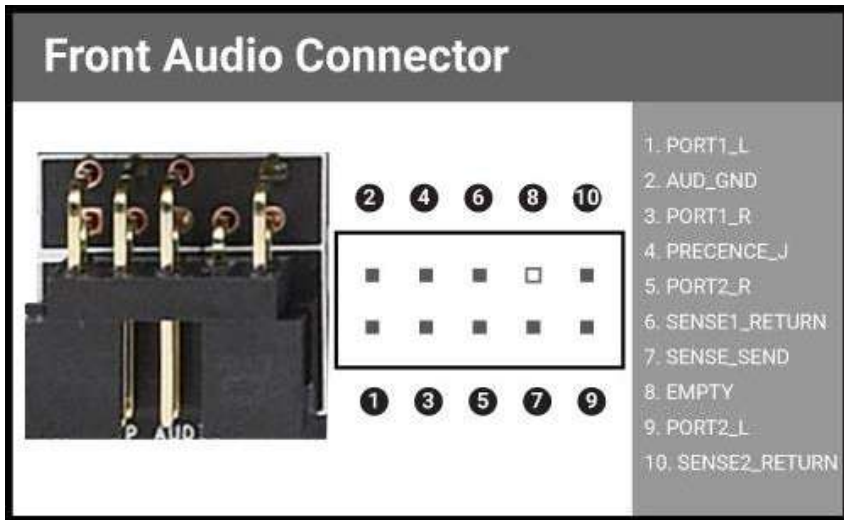

Front panel audio supports HD Audio for stereo/gaming headphones or 2.1 speakers, and a Mic.

The EVGA Z390 DARK front panel audio connector supports the use of EVGA NU Audio when headphones or a headset are connected.

## Drive Headers (SATA/ U.2)

SATA 3/6Gbit/s is the current standard for HDD/SSD/Optical interface. These cables are the data interconnect for the motherboard. Your HDD/SSD/Optical interface will still require a separate power connection from your power supply.

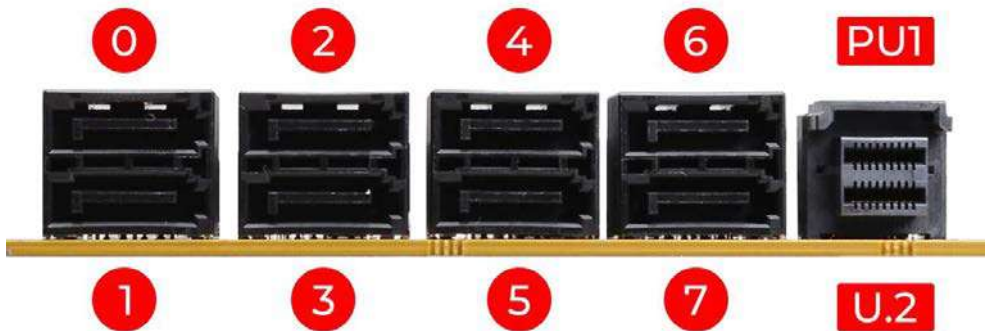

SATA ports on this platform natively support full AHCI and RAID functions. AHCI is enabled by default, but the controller can be put into RAID mode in the BIOS. RAID mode supports RAID levels 0, 1, 5, and 10 through the Intel® controller. RAID-ready ports also have full AHCI functionality.

The ASMedia SATA ports 6/7 are from the secondary SATA controller to provide additional storage ports. These ports are also compatible with some legacy Operating Systems, including Windows XP, Vista, 7, and 8/8.1. For benching enthusiasts, this allows for an easier method of achieving higher scores in your preferred Operating System, rather than be limited to only Windows 10.

U.2 is a new PCIe storage standard that has the advantage of the performance of a M.2 SSD and the ease of installation of a 2.5 inch form factor SSD. U.2 shares resources with PE1 and can be enabled or disabled in BIOS.

**See Page 54 for RAID levels supported and explanations for how they work.**



## Onboard Buttons

These onboard buttons include RESET, POWER and Clear CMOS. These functions allow you to easily turn on/off the system, reset the system or clear the CMOS.

### Clear CMOS Button

The motherboard uses CMOS RAM to store set parameters. Clear the CMOS by pressing the Clear CMOS button on the motherboard PCB or on the external I/O Panel.



External Clear CMOS Button

### RESET and POWER Button

These onboard buttons allow you to easily turn on/off the system. These buttons allow for easy debugging and testing of the system during troubleshooting situations.

The POWER button has an integrated LED, indicating the system's status. When the system is powered on, the LED remains a solid red.

The RESET button has an integrated LED, indicating the activity status of the hard disk drives and will flicker accordingly.



## First Boot

### BIOS Update

When you power on the system for the first time (or after a BIOS update/reset) it may take a little longer than expected, and follow with a warning message on the screen reading “BIOS checksum error”. This is completely normal.

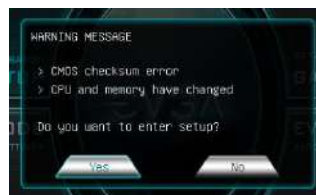

Depending on when the motherboard was purchased, compared to when it was released, there may be a BIOS update for it. If you have internet access on another PC and a USB Thumb Drive, it is highly recommended to download the current BIOS and flash the newer BIOS before attempting anything else.

If there is an updated BIOS, download and extract it onto a thumb drive formatted for FAT32, go to the EXTRAS section, select “BIOS Update,” and to navigate to where your ROM file is stored. Press Enter to update.



**\*\*IMPORTANT NOTE. DO NOT CUT POWER OR REBOOT THE SYSTEM DURING A BIOS UPDATE; YOU WILL LIKELY RENDER THE ACTIVE BIOS UNBOOTABLE\*\***

Once the BIOS is updated, you will be greeted with the same screen as before stating that there is a Checksum error. Please press “Delete” to go into the BIOS/UEFI.

The Z390 chipset is designed for UEFI mode and Windows 10 natively. However, Legacy mode is included if your older hardware is not compatible with UEFI. In most cases, there is very little setup needed on these boards.

### Memory Setup

To setup the Memory, use the arrow keys or your mouse to select the “Memory” setting. Select the “Memory Profiles” pulldown and select XMP Profile 1. This will automatically set some basic memory information, such as speed, latency and voltage. You may set the memory speed manually, if you’d

prefer, but the XMP will generally get the memory running at the memory manufacturer's specification with little to no effort.

#### HDD/SSD/M.2/U.2 Setup

Next, click "Boot" from the menu list at the top. "Boot Option #1" should show the device that you intend to install your operating system.

If you are using a standard SSD/HDD connected to a SATA port, but the device is not present in the Boot Option #1 menu, scroll down to "UEFI Hard Disk Drive BBS Priorities" at the bottom. In this menu, the top item will be "1st Boot" and will have a pulldown menu on the right. Click on the pulldown menu and select the intended drive; this will make the drive appear on the previous menu. If the drive continues to be missing, please check the troubleshooting section on Page 144.

If you plan on using an M.2 or U.2 as a boot device, click on or navigate to the "Advanced" menu, select "Onboard Device Configuration" and enable the desired port.

Once this is done, press F10 to save and exit, plug in your operating system installation medium (likely a thumb drive) and Windows 10 should be able to boot to M.2 or U.2 without issue.

**\*Note\*** Some device manufacturers require specific drivers for HDDs or SSDs (such as M.2) before Windows can detect the drive for installation. Please make sure to consult the manufacturer's instructions for your HDD or SSD before attempting to install Windows to determine if additional drivers are needed.

---

## M.2 SSD, PCIe SSD, and NVMe SSD Installation steps

M.2 is a very fast card bus that can use multiple connector types to connect many types of devices, such as WiFi or SSDs, in a very small and power efficient package. M.2 devices can be connected via an M.2 card slot or through PCIe by using an M.2 to PCIe adapter. There are also PCIe native drives of this nature, such as the Intel® 750. NVMe stands for Non-Volatile Memory Express, and is a high-performance standard for M.2/PCIe SSDs. Most NVMe drives require device drivers during the Operating System installation to be recognized as a boot drive for M.2 and PCIe varieties.

M.2/PCIe share resources with other components on the motherboard, which may limit some hardware combinations. **PLEASE SEE CHART ON PAGE 27 FOR A DETAILED BREAKDOWN OF SHARED RESOURCES.**

### M.2 Physical Installation

1. Please see Page 34 for M.2 physical installation instructions.

### PCIe Physical Installation

1. Install the SSD into any available PCIe slot with at least x4 Lanes available (Gen3 Lanes are preferred for better speed, but Gen2 Lanes will still outperform the top end of SATA SSDs).
  - a. Please refer to Page 27 under PCIe Lane Breakdown for lane specifics, as the PCIe slot must be at least x4 electrically.
2. Attach the SSD's mounting bracket to the back of the case.
3. Native PCIe drives will not normally require a separate power or data cable attached; all power and data transfers are done through the PCIe slot.

### BIOS Setup and Windows Installation for M.2 and PCIe NVMe SSDs

1. Remember, NVMe is a new standard and older operating systems do not have native support. Many NVMe drives require certain steps to make the drive bootable, even with current operating systems.  
**PLEASE FULLY READ THE INSTRUCTIONS THAT COME WITH YOUR M.2 or PCIe NVMe SSD BEFORE INSTALLATION.**
2. After reviewing your SSD's instructions and its respective Physical installation instructions above, power on the PC and enter the BIOS/UEFI by pressing the F2 key repeatedly.
3. Once in BIOS/UEFI, navigate to the "BOOT" section. Then go down to the "CSM Configuration" heading and press enter, or click on it with your mouse.

- a. For Windows 10: Set “Launch Storage OpROM Policy” to “UEFI”. Then set “Launch CSM” to “Disable”.
4. Press F10 to save and exit the BIOS/UEFI.
5. Press Del on reboot to reenter BIOS/UEFI.
  - a. If you are using a SSD-attached via PCIe, proceed to Step 6.
  - b. If you are using the motherboard’s M.2 slot, proceed to Step 8.
6. If you are using an SSD connected via PCIe (e.g. an Intel® 750) or through an adapter that connects an M.2 SSD to PCIe, go to “Advanced – PCIe Configuration” and verify that the device shows on the slot you have it installed.
  - a. Verify the lane count and PCIe Generation. It should state “x4 Gen3”.
7. Next check the Dashboard on the upper right. The populated slot, lanes used, and PCIe Generation should all match the information found in the previous step.
  - a. Proceed to Step 9 when done.
8. If you are using an SSD connected to the motherboard’s M.2 slot, re-enter the BIOS/UEFI and go to “Advanced – Onboard Device Configuration,” and set “M.2 Socket3” to “Enable.”
9. Go to the “Boot” Section, set “Boot Mode Select” to UEFI, and set first boot device to “Hard Disk:Windows Boot Manager”.
10. Press F10 to save and exit. Insert/Connect your Operating System install media and reboot.
11. Begin the Windows installation. During the drive selection step, you may need to load additional drivers that are provided by the SSD’s manufacturer, which would be covered in the SSD manual. If these steps are not followed you will likely be unable to install the Operating System to the SSD and make it bootable.

# Internal RAID Controller

This section introduces RAID, RAID levels, and the basics of the controller integrated into the PCH. It covers the basics of what RAID does, how RAID works, and why you may or may not want to use RAID.

This section is GREATLY simplified; those who have experience with RAID - especially from the server side - will find this a VERY rudimentary simplification of a process that is quite complex on the back-end. The descriptions of the RAID levels are not based on the back-end logic from the controllers, but rather just a breakdown as a visual reference to understand the basics.

For the sake of explanation in this section, every drive representation here is assumed to be 1 Terabyte (for ease of math); also the reference of P-Drive is “Physical” drive, and L-Drive is referencing “Logical” drives; physical drives are the physical drive you installed, whereas the logical drive is what Windows sees in Disk Management. This is a necessary distinction because RAID is a form of drive virtualization; taking several physical drives and making one logical drive out of them. You can add a minimum of two drives up to a maximum of six drives depending on the configuration (for this controller specifically) and the operating system will see only one logical device.

## RAID LEVELS

**ALL RAID LEVELS:** All RAID levels will lose some capacity through the process of making the array. A small amount of disk space is used, in part, to maintain connections to data across drives, but the quality and size of drives used can impact the amount.

A general rule of thumb for final array capacity is this: Take the number of drives, the array type, and individual drive capacity (for this RAID breakdown all drives are 1TB) and multiply it out as shown below for the specific RAID type you intend to use:

RAID0 = (Number of Drives) \* (Drive capacity)

RAID1 = Capacity of one drive, as all data is copied on both drives

RAID5 = (Number of drives – one drive) \* (Drive capacity)

RAID10 = (Half the number of drives) \* (Drive capacity)

To account for capacity lost both due to maintaining the array as well as what is lost during the formatting process, multiply the product by .85 and you should see a volume close to this number once the array is partitioned. This will vary based on type of drive,

its quality, and many other factors; but the number should give you a ballpark estimate on what to expect as a final capacity once formatted.

Please see below for examples of what to expect when you build an array of each type. Each RAID type will use diagrams to illustrate functional and non-functional forms of each RAID; all green items indicate a drive that is functional, and red indicates a drive that has failed.

**BEFORE BUILDING AN ARRAY, BE SURE YOUR SSDs OR HDDs ARE THE SAME MAKE, MODEL, AND CAPACITY. MIXING DRIVES CAN CAUSE ANYTHING FROM ODD PERFORMANCE ISSUES, ARRAYS DE-SYNCING, LARGE SCALE DATA CORRUPTION, AND/OR UNRECOVERABLE ARRAY FAILURE. MAKE SURE THAT YOUR INTENDED HDD SUPPORTS RAID; IF NOT, THE DRIVE MAY CAUSE CONSTANT DESYNCRONIZATION ISSUES DUE TO DATA TTL TIMERS NOT SENDING AN “ALL IS WELL” SIGNAL WITHIN THE EXPECTED TIMEFRAME, WHICH WILL SEND THE CONTROLLER THE MESSAGE THAT THE DRIVE HAS FAILED OR DISCONNECTED.**

If you are unsure about any of the bolded section above, please contact the drive manufacturer’s customer service to make sure the device is supported for RAID. If the drive is not, the controller cannot work around it and make it function as intended.

**RAID0:** This type of array is often referred to as “Striping” or a “Striped Array.” RAID0 takes a data set and spreads it equally across two (2) or more drives. The logic behind this array is that reading a single file, for example, will be much faster if the file is spread across two (2) or more drives and read from both drives simultaneously; thus reducing the time each drive spends in the read process by at least 50% rather than being read from one source. The file is then reassembled once the data hits RAM. This is similar, in theory, to how multi-channel memory or SLI works: load balancing for storage.

Because RAID0 is only designed to distribute the data being written across multiple devices to improve performance there is **\*\*NO FAULT TOLERANCE\*\***, meaning if

one drive fails, the array fails. It MAY be possible to recover the data but that usually requires a data recovery service, which is not guaranteed and is usually very expensive.

RAID0 is typically only limited by the controller; however, you will get severely diminishing performance returns after 4 drives. If you go above 4 drives, you will also see more capacity loss after creating the array.

The Good-

- it can greatly increase the read/write speed of drives
- The most storage capacity-friendly use of drive space compared to other array types.

The Bad

- RAID0 has no redundancy, which makes it very volatile, if you lose even 1 drive, you lose everything.
- If you use this method, make sure to back up often.

Below is the breakdown of RAID0's function and the breakdown of a drive failure in this type of array. Wherever you see the section labelled "DATA" at the bottom turn red, this indicates an array failure.

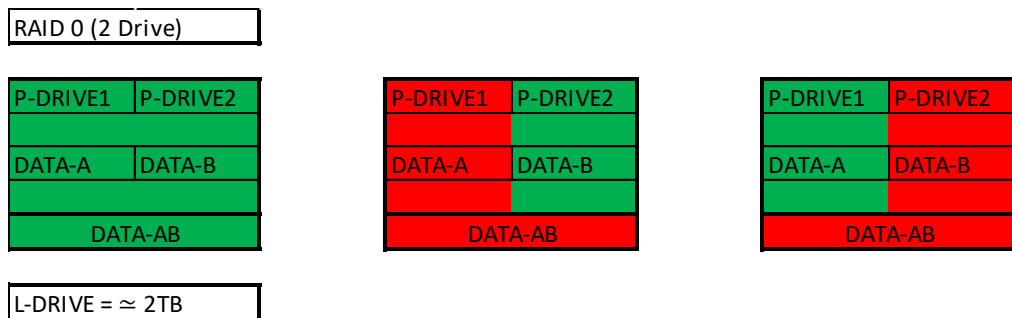

As RAID0 has no fault tolerance, even a single drive failure compromises the array and renders the array Failed and unrecoverable.

The array depictions below show how this issue scales to larger arrays. In fact, due to the lack of fault tolerance, the potential failure rate actually increases because of the addition of more drives that can physically fail.



RAID 0 (4 Drive)

P-DRIVE1	P-DRIVE2	P-DRIVE3	P-DRIVE4
DATA-A	DATA-B	DATA-C	DATA-D
DATA-ABCD			

P-DRIVE1	P-DRIVE2	P-DRIVE3	P-DRIVE4
DATA-A	DATA-B	DATA-C	DATA-D
DATA-ABCD			

P-DRIVE1	P-DRIVE2	P-DRIVE3	P-DRIVE4
DATA-A	DATA-B	DATA-C	DATA-D
DATA-ABCD			

P-DRIVE1	P-DRIVE2	P-DRIVE3	P-DRIVE4
DATA-A	DATA-B	DATA-C	DATA-D
DATA-ABCD			

P-DRIVE1	P-DRIVE2	P-DRIVE3	P-DRIVE4
DATA-A	DATA-B	DATA-C	DATA-D
DATA-ABCD			

L-DRIVE = ≈ 4TB

**RAID1:** This type of array is referred to as “Mirroring” or a “Mirrored Array.”

RAID1 uses two (2) physical drives and writes ALL data to both drives simultaneously providing a 1 to 1 mirror, giving you 100% redundancy live. So as data is being written, if a drive fails you are still up and running. In most cases, when a failure occurs you will experience a stutter in performance and a small but noticeable slow down. Next, you’ll likely see a popup warning from IRST alerting you that a drive has failed or is disconnected, and your array’s status has been changed to “Degraded”.

RAID1 (at least on these PCH driven controllers) are limited to 2 drives. Also being that this is a mirror, you will use 50% of your capacity in redundancy.

The Good-

- RAID1 allows you to suffer a catastrophic failure of 1 drive with no ill effects to the data being stored.
- Because data is stored on 2 drives at once, read speeds typically increase a little, but not to the speed of RAID5 and, certainly, not to the speed of RAID 0.

The Bad-

- RAID1 is not a storage capacity-friendly array, because the capacity will be limited to 1 drive.
  - Due to the capacity available on modern drive solutions, this issue may not be as significant as it once was.
- Write speed will be a bit lower than a single drive.

In the charts below, you can see the effect of fault tolerance when using a mirror array: because all data has a direct 1-to-1 duplicate on the mirrored drive, you can suffer a catastrophic failure of a drive and still retain your data. For a RAID1 array to lose its data, both drives must fail.

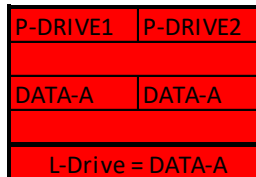
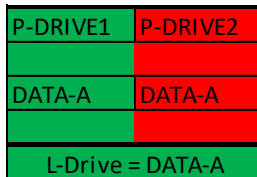
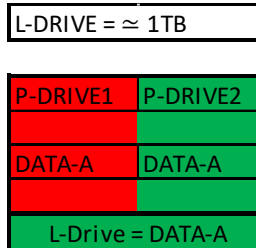
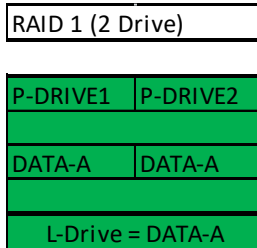

**RAID5:** RAID5 is a stripe with Fault Tolerance, which attempts to bridge the gap between speed and redundancy. This level will always reserve a capacity equivalent to one drive for fault tolerance, regardless of the overall capacity. This means that if you use four 1TB drives to create your RAID5, you will only have the capacity of three 1TB drives; likewise, if you use five 1TB drives to create your array, you will only have the capacity of four 1TB drives. RAID5 requires a minimum of three drives, and the maximum is set by the RAID controller; this level works well when using between four to six drives, but sees diminishing returns beyond six.

Similar to RAID1, or any other current type of array with fault tolerance, a RAID5 array is still usable even while it is experiencing a missing or failed drive resulting in the array functioning in a degraded state. Performance will suffer in a degraded state until the missing drive is replaced and the software rebuild process is completed. During the rebuild process, performance will be severely degraded and can take several hours, depending on the size of the array and percentage of capacity used.

#### The Good-

- Most space efficient array-type that also has fault tolerance.
- Initial array builds quickly
- Read/write speed is very good; faster than RAID1 but slower than RAID0

#### The Bad-

- Rebuilding an array can take a long time on an integrated PCH controller, especially when using a very large array with multiple drives or capacity.
  - For this reason, RAID5 is sometimes more beneficial on a dedicated RAID controller.
- If more than one drive fails at once (not likely, but still possible) you will suffer a total loss of data; the array will behave like a RAID0 losing a drive.
- RAID5 is close to outliving its usefulness because it was created, in part, to create large size arrays with fault tolerance. Due to the capacity available on modern drives, other RAID solutions are now better and with fewer downsides.

RAID5 protects data rotating parity (there are several terms coined by different RAID manufacturers over the years for RAID5 and they all mean roughly the same thing), which means taking small portions of data, duplicating them and putting them onto different drives. When a drive that has failed is replaced, its data is recreated by the remaining drives in the array, which will require a very high volume of small data segments copied back over to the replacement drive while also maintaining the array's index of data. Once the rebuild is complete, current data can be read from the new drive and new data can be written to it.

The RAID5 diagram below is a bit more complicated than the others, due to the nature of how data is distributed. In the diagram you will see that there is one more Physical drive than there is data set. This method of data distribution shows that as long as you have three (3) copies of each data set (Data-A, Data-B, and DATA-C), the array will be functional and capable of rebuilding when you add in replacement drive in. And while this is not mathematically correct for HOW the data distribution works, it is a good visualization to understand the basics of how it works.

RAID 5 (4 Drive)

P-DRIVE1	P-DRIVE2	P-DRIVE3	P-DRIVE4
DATA-A	DATA-B	DATA-C	DATA-A
DATA-B	DATA-C	DATA-A	DATA-B
DATA-C	DATA-A	DATA-B	DATA-C
L-Drive = DATA-ABC			

P-DRIVE1	P-DRIVE2	P-DRIVE3	P-DRIVE4
DATA-A	DATA-B	DATA-C	DATA-A
DATA-B	DATA-C	DATA-A	DATA-B
DATA-C	DATA-A	DATA-B	DATA-C
L-Drive = DATA-ABC			

L-DRIVE = ≈ 3TB

P-DRIVE1	P-DRIVE2	P-DRIVE3	P-DRIVE4
DATA-A	DATA-B	DATA-C	DATA-A
DATA-B	DATA-C	DATA-A	DATA-B
DATA-C	DATA-A	DATA-B	DATA-C
L-Drive = DATA-ABC			

P-DRIVE1	P-DRIVE2	P-DRIVE3	P-DRIVE4
DATA-A	DATA-B	DATA-C	DATA-A
DATA-B	DATA-C	DATA-A	DATA-B
DATA-C	DATA-A	DATA-B	DATA-C
L-Drive = DATA-ABC			

P-DRIVE1	P-DRIVE2	P-DRIVE3	P-DRIVE4
DATA-A	DATA-B	DATA-C	DATA-A
DATA-B	DATA-C	DATA-A	DATA-B
DATA-C	DATA-A	DATA-B	DATA-C
DATA-ABC			

P-DRIVE1	P-DRIVE2	P-DRIVE3	P-DRIVE4
DATA-A	DATA-B	DATA-C	DATA-A
DATA-B	DATA-C	DATA-A	DATA-B
DATA-C	DATA-A	DATA-B	DATA-C
L-Drive = DATA-ABC			

**RAID10:** RAID10 is the only level of nested RAID currently supported by the integrated PCH controller. Nested RAID is the process where a controller makes multiple RAID arrays, treating each of them as their own device and applies them to ANOTHER RAID level. This type of virtualization allows you to have an array where each node has its own level of redundancy.

In the instance of RAID10, it is two (2) or more Mirrored arrays (RAID1s) that are striped together (RAID0). In effect, this is RAID0 where every physical drive (now logical drive due to nested RAID functions) in the array is internally redundant via a mirror. This means you can lose a drive and the data set is still present; when the drive is replaced, it is replicated by the data internal to that node.

RAID10 is highly scalable. RAID10 always scales in two (2) drive increments, starting with a minimum of four (4) drives. This motherboard series supports a four (4) drive RAID10 array. Lastly, RAID10 is a mirrored array, which means it shares the same 50% drive capacity, as all data has a 1:1 copy.

The Good-

- Excellent Fault Tolerance
- Good rebuild times
  - Vastly superior rebuild times compared to the previous 0+1 methodology of nested RAID.
- Overall performance is good; comparable or slightly faster than RAID5.

The Bad-

- Low space efficiency.
  - With the capacity of modern drives, this will likely be less of a consideration than in previous years.

The fault tolerance works a bit differently in RAID10 than in others because the array has nodes with internal redundancy. In other words, although a four drive array can lose two drives and remain operational, it greatly depends on WHICH two drives fail. If both drives from the same node fail, then half of the data is gone and the array has failed. However, every node, regardless of the number of total nodes, can suffer one internal failure with no adverse effects.



While the Z390 DARK controller will support a four drive RAID10 array, RAID10 can scale indefinitely provided the controller supports more drives. Every pair of drives adds an additional mirrored node, which increases the theoretical number of failures the array can suffer before a loss of data occurs. However, an array can still fail due to both drives on a node failing.

In the case of a drive failure, the array controller will notify you. When you replace a failed drive in the RAID10, rebuilding the array is mostly seamless.

For example, look at the array on the second row to the right. P-Drive1 failed, but P-Drive2 is still working and uses the same data. The array will pull data from P-Drive2 during the rebuild, so the array can be used normally while P-Drive2 copies ALL of its data back to the drive replacing P-Drive1.

The rebuild process will only rebuild 1TB worth of data because only one node failed. There will be a performance hit during the rebuild process, which can be further delayed if VERY data intensive applications are used, but overall performance of the array will still be fast enough to run effectively during the rebuild. RAID10 rebuilds much more quickly than its predecessor RAID0+1.



**RAID0+1:** RAID0+1 is a form of nested RAID that was widely used on previous generation boards. Although the Z390 series motherboards do not use this type of array, it is listed here to show the improvements made by RAID10, and to clear up a common misperception that RAID0+1 and RAID10 are the same.

A RAID0+1 array is created from two (2) stripe sets that are mirrored together. Similar to RAID10, RAID 0+1 requires a minimum of four drives, and is highly scalable in two drive increments. Again, because RAID0+1 is a mirrored array, it shares the same 50% drive capacity, meaning that four 1TB drives in RAID0+1 will result in a 2TB array.

Where 0+1 differs from 10 is in how the drives are split, and the data distributed. While RAID10 is created using two or more mirror sets striped together, RAID0+1 is two striped sets mirrored together. When scaling with additional drives (in multiples of two), RAID10 adds the drives as another mirrored set to the striped array, whereas RAID0+1 splits the drives between the two stripes to maintain the mirror. To the end-user, the final result appears very similar; however, the significant differences lie in fault tolerance and recovery.

In a RAID0+1, ANY drive failure results in half of the array becoming effectively failed. If one drive fails, that stripe fails, and the mirrored stripe takes over. When the failed drive is replaced, the entire capacity of the mirrored array must be rewritten to the failed array, rather than one drive's worth of capacity (i.e. RAID10). This makes the RAID0+1 array more volatile than RAID10, despite being fault tolerant, and can also increase rebuild times at an exponential margin for large arrays.

Like RAID10, RAID0+1 can afford to lose up to half the number of drives in the array and still be protected; however, this is contingent on the failed units being all from the same stripe set. If one drive fails from both stripe sets at once, the entire array is lost.

The Good-

- Fastest of the standard nested RAID types
- Performance scales with drive count.

The Bad-

- Build times can be substantially longer than RAID10 due to the volume of data being moved, and is typically close to the rebuild times of RAID5.
- Low space efficiency, only 50% of total drive capacity is usable in the array.
- 1 drive failure drops a full stripe set.

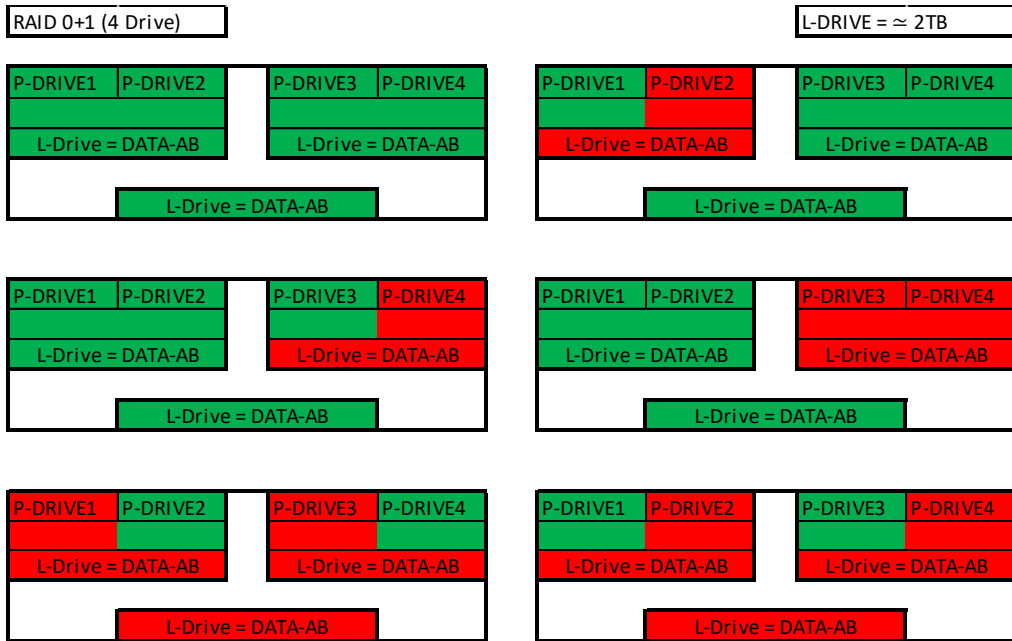

Motherboard controllers that support RAID0+1 (such as on older generation EVGA motherboards) will generally support 4 or 6 drive arrays of this type; other controllers can allow this array type to scale indefinitely. Each pair of drives adds to the drive count for the stripes and increases the theoretical volume of failures the array can suffer before a loss of data occurs. However, this type of array can fail due to any two drives on different stripes failing at once; this is RAID0+1's main drawback. Theoretically, at six drives and above, RAID0+1 should have slightly faster read/write speeds compared to RAID10 because the stripes are larger without the overhead of an internal mirror. This is because RAID10 increases both the number of mirror sets as the array scales upwards and the backend calculations needed to maintain the arrays, whereas RAID0+1 only increases stripe size.



As you can see, the difference between RAID0+1 and RAID10 is significant when looking at how data is stored. Although the drive volume scaling and the level of fault tolerance is the same, internalizing the redundancy can make a significant difference overall to the array.

In the examples to the right, you can see that when one drive fails the entire stripe set fails; for a RAID0+1, you would need to rewrite 3TB worth of data back onto the failed node when rebuilding, rather than 1TB for the same drive count on a RAID10.

RAID10 is the current standard on Intel® PCH based RAID controllers, largely because the fault tolerance for it is a bit more forgiving and the rebuild speed is overall significantly faster than its RAID0+1 predecessor.



## Which types of RAID can I use with my setup?

- 1 Drive – No RAID arrays are supported
- 2 Drives – RAID0 for speed (do regular backups) or RAID1 for data protection.
- 3 Drives – RAID0 for speed (do regular backups) or RAID5 for speed and protection.
- 4 Drives – RAID0 for speed (do regular backups), RAID5 for speed and protection, RAID10 for the best balance of Speed and protection.
- 5 Drives – RAID0 for speed (do regular backups), but it will start to show diminishing returns on performance; and RAID5 for speed and protection.
- 6 Drives - RAID0 for speed (do regular backups), but very marginal performance difference over 4 or 5 drive stripes; and RAID5 for speed and protection.

Also, you can run more than one array on your controller, so long as the total is under six (6) drives.

## Configuring the Array

Please note that this section was configured with an earlier version of the EVGA GUI BIOS. The current GUI BIOS may look different, but will follow a similar set of steps to create and repair a RAID volume.

Attach all SATA devices you intend to use, and make sure power is attached. Power the system on. Press the “Delete” key repeatedly to enter BIOS. Once into BIOS you will need to enable the RAID function of the board.

Once into BIOS, click on (or navigate with your arrow keys) the “Advanced” tab at the top, and then on “SATA Configuration.”



In the “SATA Mode Selection” at the top, the default will be AHCI. Click on the arrow to the right side of AHCI or navigate to it with your keyboard and press “Enter” to open the pulldown menu. Select RAID from the list.

RAID mode not only includes the RAID controls, but also shares the same options/functions/commands as AHCI; you may continue using your AHCI devices normally when the SATA Configuration is set to RAID mode.

The SATA Information menu shows a list of all drives currently detected by the controller; make sure the list in your BIOS matches what you have plugged in. If it does not, reseal cables on the device(s) in question. If the issue persists, please check the troubleshooting section on Page 144.

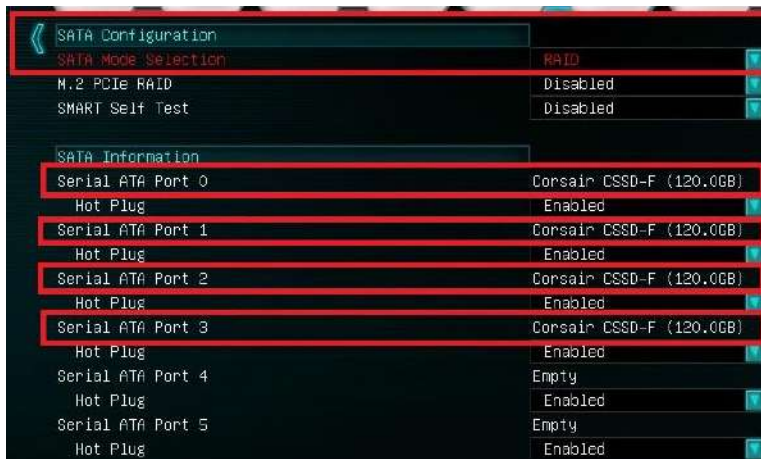

Once RAID is enabled and all devices are detected, press F10 to save and exit. Upon reboot, repeatedly press “Delete” to reenter the BIOS. Once in the BIOS, go back to the “Advanced” tab where you’ll find a new item at the bottom of the list called “Intel® Rapid Storage Technology.”

The Intel® Rapid Storage Technology utility in the BIOS replaces the Intel® RAID manager that was previously launched outside of the BIOS in previous generation motherboards. Due to the current bootup process, speed of processors, and UEFI the previous method made accessing the Intel® RAID manager nearly impossible. This is the same controller that was previously accessed by CTRL-I; now, it is fully accessible within the BIOS/UEFI.



Once in the RAID controller, you will see a list of all detected drives and a “Create RAID Volume” button. To begin, click on “Create RAID Volume” or navigate to the button and hit “Enter.”



Choose a name for the volume. The controller allows up to 15 characters; you can use numbers and letters, but not special characters.

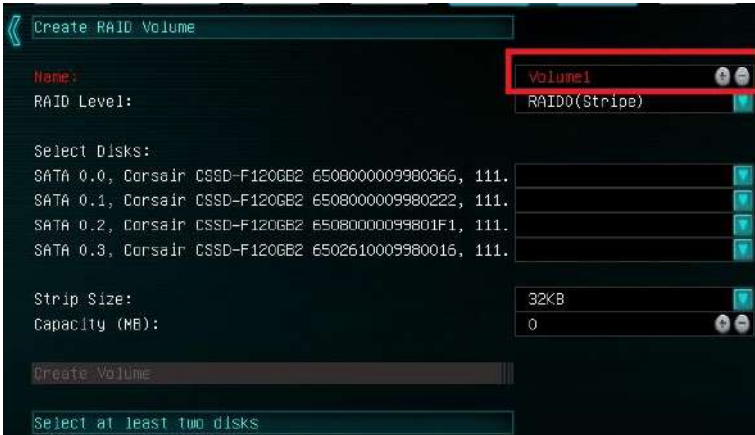

Next, select your intended array type. This can be done by either clicking on the down arrow and clicking on the RAID level you want, or pressing the enter key and using the down arrow to select the RAID level and pressing Enter again. Please see the top half of Page 66 for a quick reference on different RAID levels and RAID types based on your total number of drives.

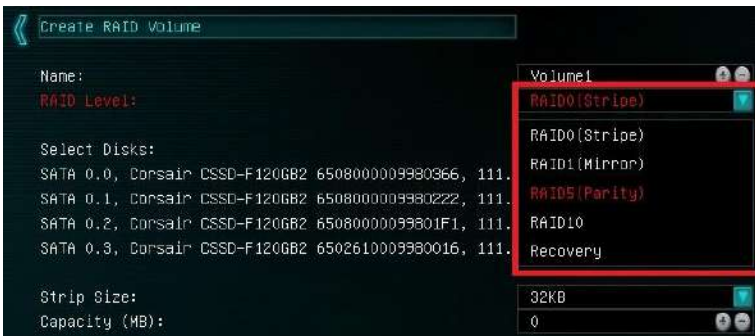

Next, select the drives you want to use for the array. Select the down arrow and the “X” for each drive you want to include in the array.

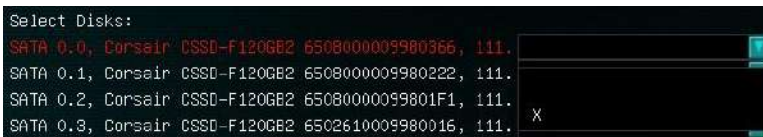

Strip size (also called “block size” in other controllers) can be selected manually at 16k, 32k, 64k, or 128k. The controller will determine the default strip size after looking at your drives and array type. Although there are some limited instances where this must be set manually, it is highly recommended to leave this at default.

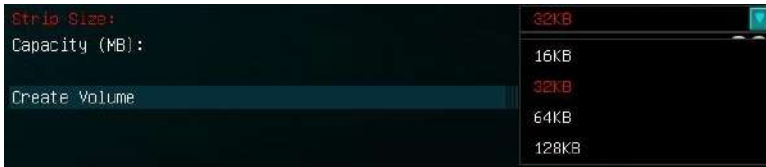

The controller defaults the capacity to the maximum available space for the RAID. Leaving the capacity at default is recommended because reducing the size is not beneficial, except in limited cases.

To complete the setup process, please select “Create Volume” at the bottom of the page. Depending on the array type, drive type, and volume this can take a few seconds to a few minutes.



Once the array is completed you will see the text shown on the next page, or something similar based on the array type and drives used. At this point, the array is ready to use.



If your array will be your boot drive, the operating system will normally detect the array and see it as a single drive (this is expected), it \*MAY\* detect it as a RAID array; either way, the OS installation will show the size of the array, not a single drive, and allow you to install the OS to the array without any further steps. However, depending on the OS version, you may need to install RAID drivers for the RAID array to be detected.

If this is meant to be a secondary array, your next step is to partition and format the array within Windows. Please see Page 84 for setup in Windows 10.

## Repairing an array within UEFI

This guide will show you how to repair a degraded array from within the UEFI. For testing purposes, a drive was intentionally removed from a RAID5 array and wiped to guarantee that the array rebuild behaved the same as if a new replacement drive was added to a degraded array.

If a drive fails and the array becomes degraded, you will typically see an alert in Windows, during the controller booting (Legacy mode only), or while checking the array status within UEFI. If a drive fails in an array with redundancy (a RAID5 array, in this case), the controller will report the array as “Degraded” (see pic below). This means that the array has a node down, the data is still intact, but your fault tolerance is reduced.



Highlight the degraded array with your mouse or navigate to it with your keyboard and select it to bring you into the array screen (see image on next page), which will show you your array status and any drives that are not currently configured in a RAID array. The Non-RAID Physical Disks list will display any remaining drives on the controller, whether it is a random storage drive, a boot drive, or a replacement drive installed to replace a failed unit. For this example, you will see a degraded array and a “Non-RAID Physical Disk,” which we’ve attached to repair the degraded array.

The drive attached is an exact match to the other drives in our RAID 5; however, you can use a different drive if it is the same size and preferably same type/series, as well.

**\*\*ALL DATA ON THAT DRIVE WILL BE REMOVED AND WILL NOT BE RECOVERABLE WHEN ADDING IT INTO THE ARRAY\*\***

The controller will also give you this information, but it cannot be overstated that using a drive with data on it will result in the total loss of all previous data in favor of the data on the array.

```

< Intel(R) RST 14.6.0.2285 RAID Driver

RAID Volumes:
Volume1, RAID5(Parity), 335.4GB, Degraded

Non-RAID Physical Disks:
SATA 0.2, Corsair CSSD-F120GB2 65080000099801F1, 111.7GB
  
```

Select the degraded RAID volume, then select “Rebuild” on the following menu.

```

< RAID VOLUME INFO

Volume Actions
Delete
Rebuild

Name: Volume1
RAID Level: RAID5(Parity)
Strip Size: 32KB
Size: 335.4GB
Status: Degraded
Bootable: Yes

RAID Member Disks:
SATA 0.0, Corsair CSSD-F120GB2 6508000009980366, 111.7GB
SATA 0.1, Corsair CSSD-F120GB2 6508000009980222, 111.7GB
SATA 0.3, Corsair CSSD-F120GB2 6502610009980016, 111.7GB
  
```

Next, you will see a list of all attached HDD/SSDs that can be used to rebuild the array. Select the disk, then click on it or press enter.

```

< Rebuild Volume

SATA 0.2, Corsair CSSD-F120GB2 65080000099801F1, 111.7GB
  
```



Once the process has started you will see the status change to “Rebuilding.”



```
Intel(R) RST 14.6.0.2285 RAID Driver

RAID Volumes:
Volume1, RAID5(Parity), 395.4GB, Rebuilding
```

**\*\*Important Notice\*\*:** The controller will not begin the rebuilding process until you have booted back into Windows; this queues the rebuild but does not start the process. The rebuilding duration will vary. Fast drives in uncomplicated arrays with small amounts of data can rebuild very quickly. Large platter drive-based arrays, especially in RAID5, can take several hours to rebuild. The duration of the rebuild process will further increase based on the usage of both the array and the CPU during the process. The rebuild process can be monitored from the “Intel® Rapid Storage Technology” utility in Windows, which is effectively the software front-end for the Intel® SATA controller. The rebuild status can be viewed in the “Manage” tab, located on the top of the IRST Window. Please see the image at the top of Page 83 to see an example of where to find the rebuilding % in the IRST.

## IRST (Intel® Rapid Storage Technology)

The IRST is the software front-end for the Intel® SATA controller. It is recommended to install the IRST drivers after installing the Intel® Chipset Drivers – the main motherboard drivers. This guide walks you through not only the building, but also the repairing of an array from within Windows, since it may be more convenient to build new arrays within the OS rather than from within the UEFI. All forms of RAID that can be built in the UEFI are available in IRST; the IRST may be more convenient for some people due to a more detailed UI than the UEFI.



This guide will illustrate how to create a RAID1 array using the IRST. Using the screen above, we know that three (3) SSDs are currently attached to the controller and the other three (3) INTEL® SATA ports are empty (this can vary board to board based on how many Intel® SATA ports are present). If you plan to create another type of array, please ensure that you have the correct number of drives attached and shown on the status screen in IRST for your intended array before you start.

Referring to the above image, again, locate and click the hyperlink halfway down the window that says “Create a Custom Volume.” An array creation window will open:

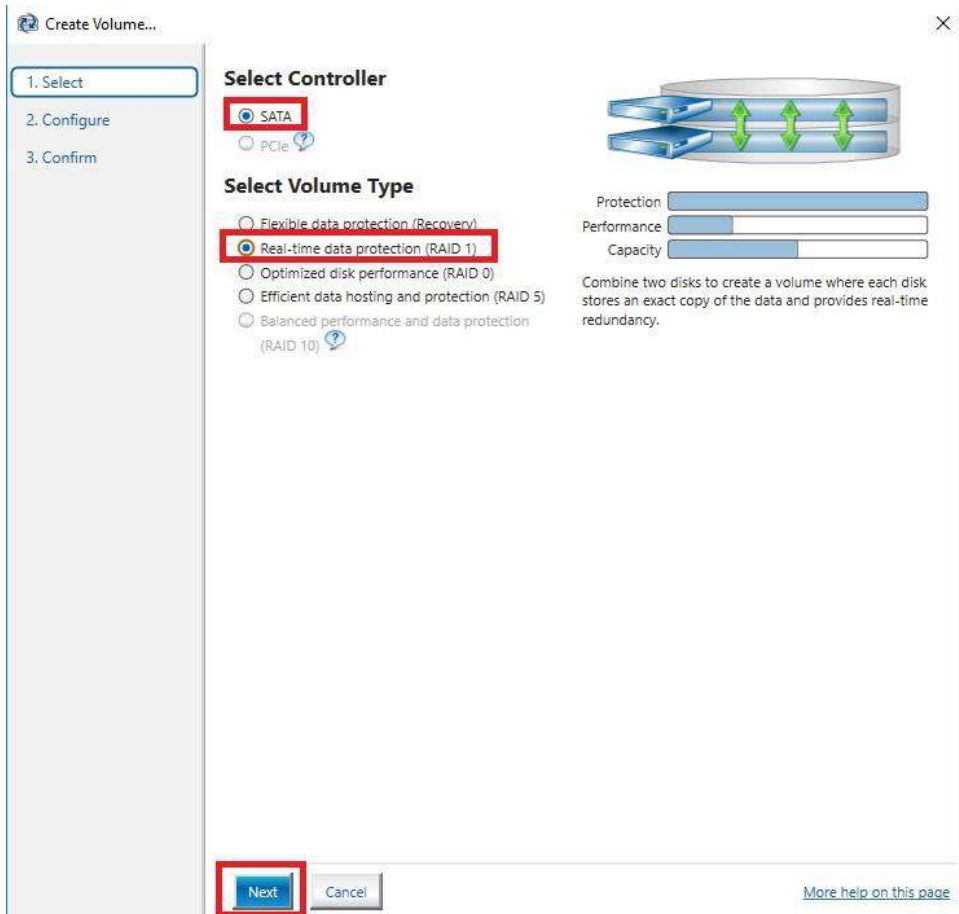

SATA will be selected by default. PCIe primarily refers to PCIe / M.2 based NVMe drives; the same basic steps do apply to both, however. Select SATA, and “Real-time protection (RAID1).” Then, click Next at the bottom of the window.

RAID1 can only support two (2) drives. Left-click the open boxes from the list below to select your two preferred drives. You may also name the array anything you like. Although you have the option to define volume size, it is recommended to leave the array at 100%, which is the default.

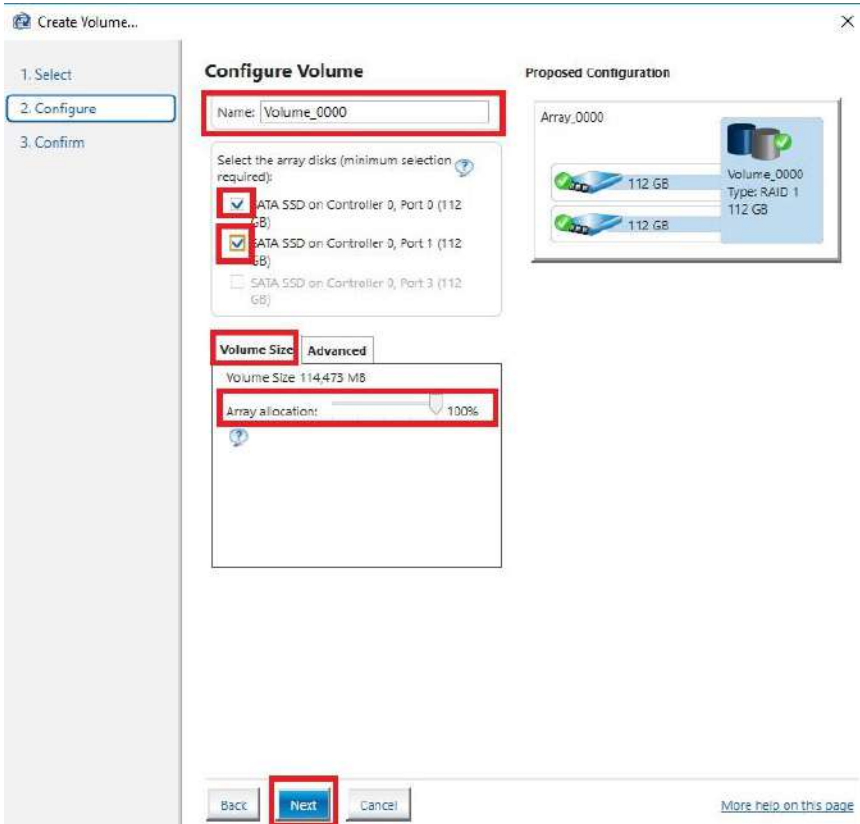

In the Advanced tab, you can select the option to “Initialize Volume,” which will occur after the array is created. If the array is not initialized now, it can be initialized later in “Disk Management.” See Page 84 for Disk Management instructions.

When done, click “Next” at the bottom.

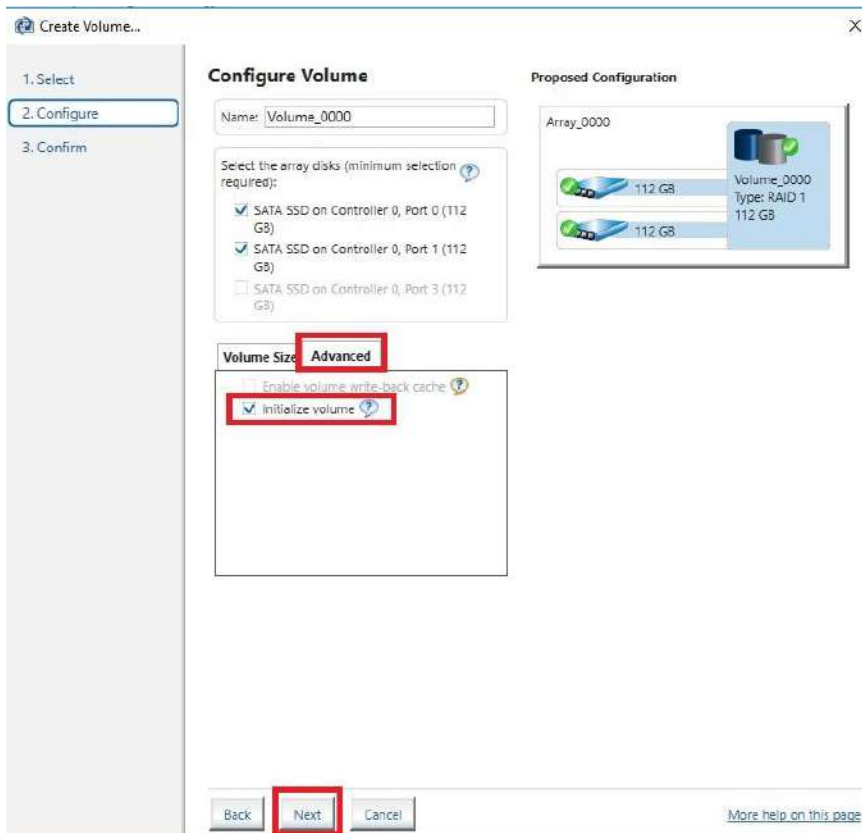

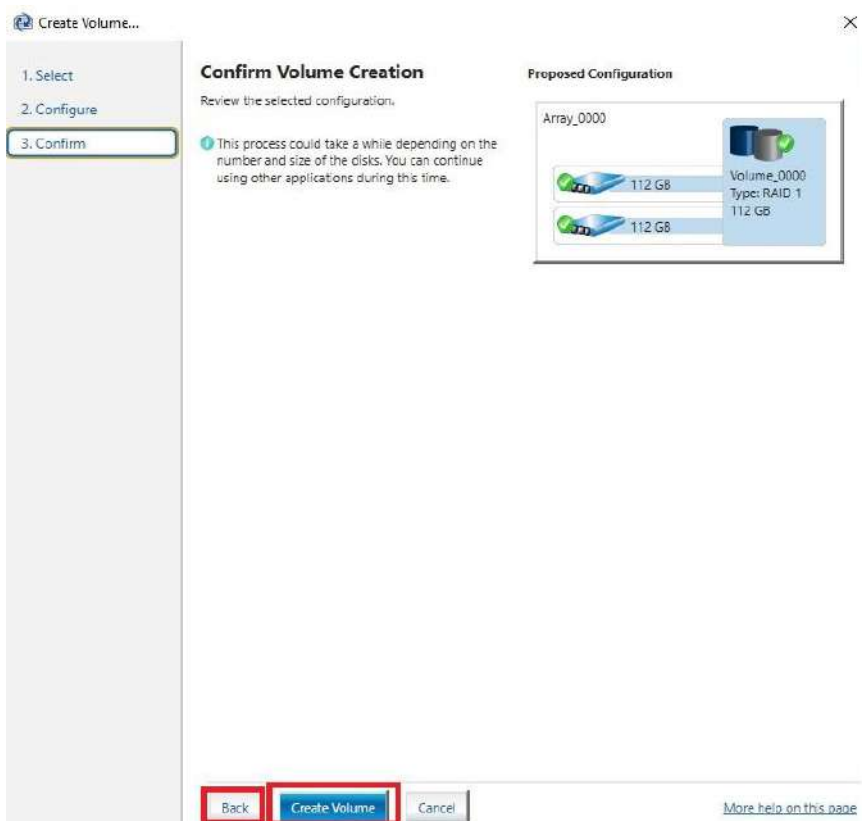

Review the summary provided on the confirmation screen. If you are unsure about any selections made, click the “Back” key and make your corrections. When ready, click “Create Volume” at the bottom. This typically takes between a few seconds to a couple minutes depending on the size and complexity of the volume. Once finished, you will see the message below. The array is now ready to be partitioned, formatted, and used.



Once you click the OK button on the RAID creation window you will be brought back to the main window, “Status” tab. If the option to initialize was selected, the initialization status will be shown below, circled in red.



If you select the “Manage” tab, you can see a bit more in-depth information on the array and additional options to manage or change the array.

Before the drive can be used, however, the drive must be partitioned, formatted, and assigned a drive letter. Please see Page 84 for instructions.



## Repairing an array within IRST

This section of the guide will illustrate how to repair a degraded array from within the IRST. For purposes of this guide, we are repairing a degraded RAID 1 array using a third drive plugged into the controller, but not currently in use.

Below, you can see a degraded array, and one of its drives reported as missing/failed. The data on the other drive is still intact, but the fault tolerance is offline due to the missing/failed drive. The IRST also shows several warnings, the "!" for "Status," a "!" for the portion of the array missing (showing the degradation of the logical drive), and the "!" for the physical drive, which also states 0GB – a further indicator of a faulty drive. You can repair the array from here or from the Manage tab at the top of IRST.

The screenshot displays the Intel Rapid Storage Technology (IRST) application window. The interface includes a navigation bar with tabs for Status, Manage, Performance, Preferences, and Help. The main content area is divided into two sections:

- Current Status:** A warning icon is present. The text states: "Your system is reporting one or more events, and data may be at risk. Refer to the details below for more information." Below this, there is a "Manage" section with a "Manage" button and a note about the Windows write-cache buffer flushing policy. The "SATA\_Array\_0000" section shows "Volume\_0000: Degraded" with a "Rebuild to another disk" button. Below this, it says "Unknown disk on Controller 0, Port Unknown: Missing". At the bottom, it shows "SATA SSD on Controller 0, Port 2: Offline" with a "Clear metadata" button.
- Storage System View:** This section shows a RAID 1 array named "SATA\_Array\_0000". It contains two drives: "Volume\_0000" (Type: RAID 1, 112 GB) and a drive showing "0 GB" with a warning icon. Below the array, there are three "Internal empty port" entries (ports 0, 4, and 5).



The “Manage” tab shows the array specifically, and not just the controller as a whole.

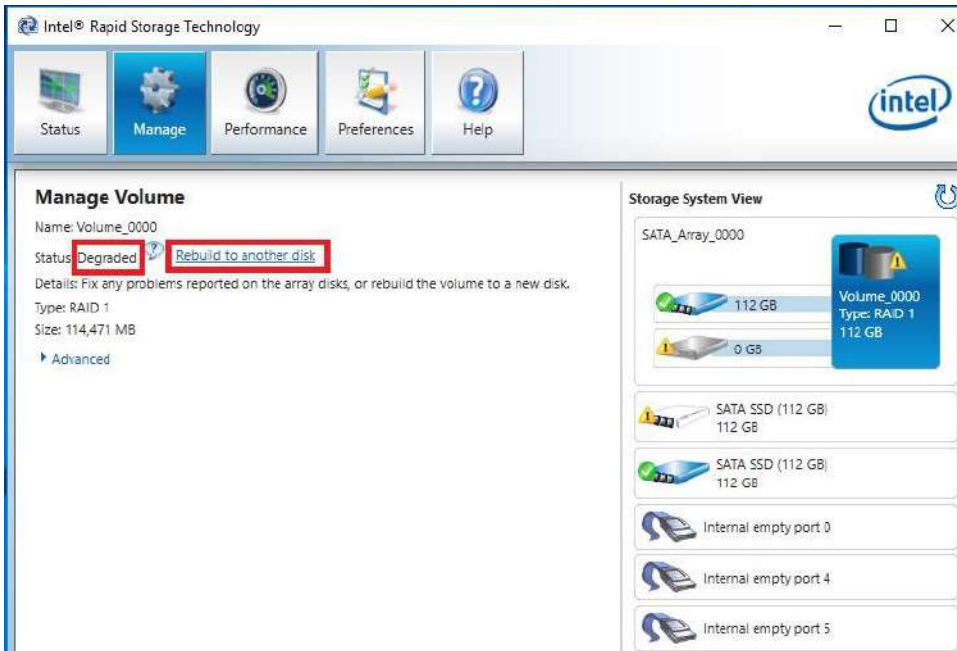

Next to “Status: Degraded,” left-click the hyperlink labeled “Rebuild to another disk.” This will bring a pop-up window over the IRST showing a list of attached drives that can be used for the repair (see pic on next page):



Select the drive you wish to use for the repair and click the “Rebuild” button.

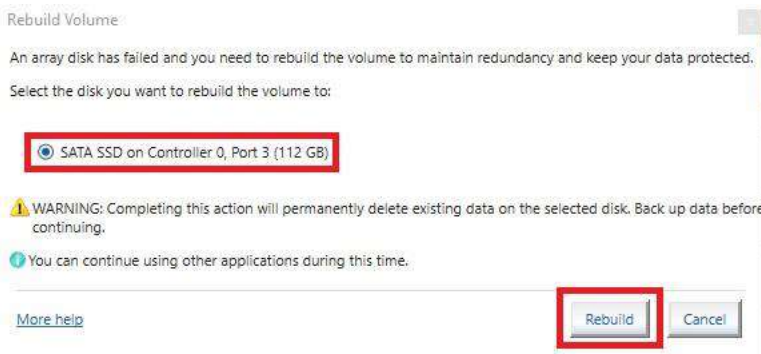



The rebuild process will begin. As with any RAID array with Fault Tolerance, the rebuilding time depends on several factors, such as array size, array type, CPU, etc. You will then see the Rebuild % status in the Manage tab. Once repairs are complete, the array will update to “Status: Normal.”

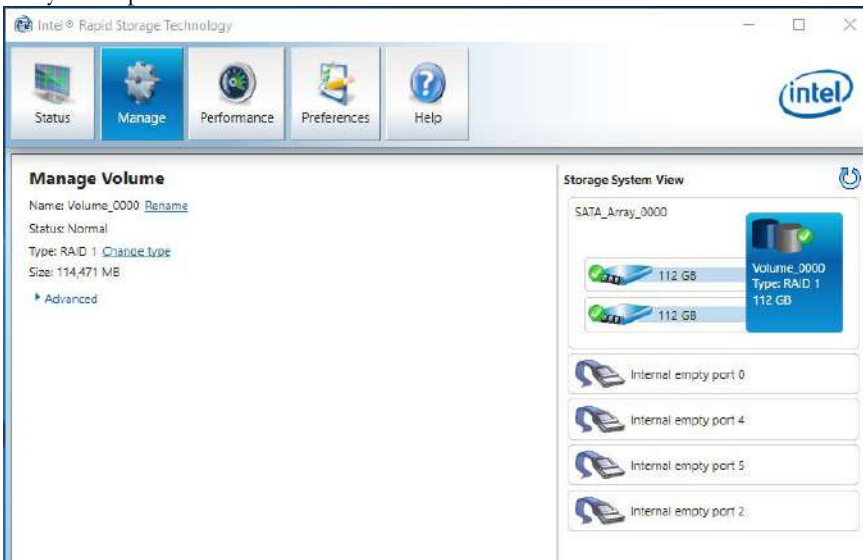

## Partitioning and Formatting a drive

Once you have created your array, either from UEFI or from IRST, you will not initially see your array in “This PC.” This is expected, because even though you have created the array, you have not yet prepared the array to be used.

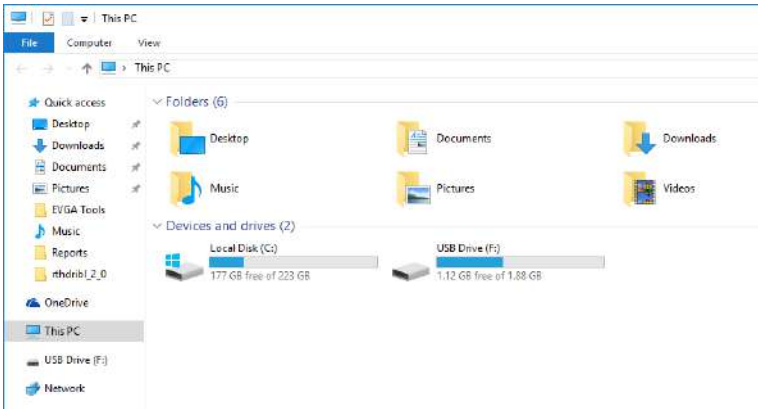

To begin, you'll need to go into Disk Management.

Windows 10: Right-click on the Windows Start button and select “Disk Management.” Alternatively, press the Windows Key + X on your keyboard and select “Disk Management.”

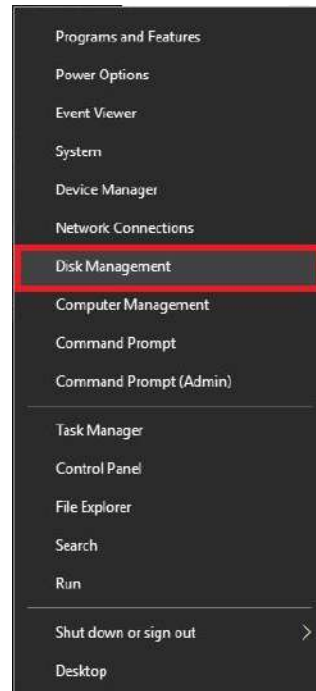

After “Disk Management” loads, you’ll see a pop-up to Initialize Disk if you’ve added a new drive or created a new array.

Generally, it’s recommended to select “GPT,” unless you need backwards compatibility with an old OS or PC. When you’ve made your choice, click “OK.”

Note: If you previously initialized your array through IRST, you will skip this step and move on to the New Simple Volume Wizard in the next step.

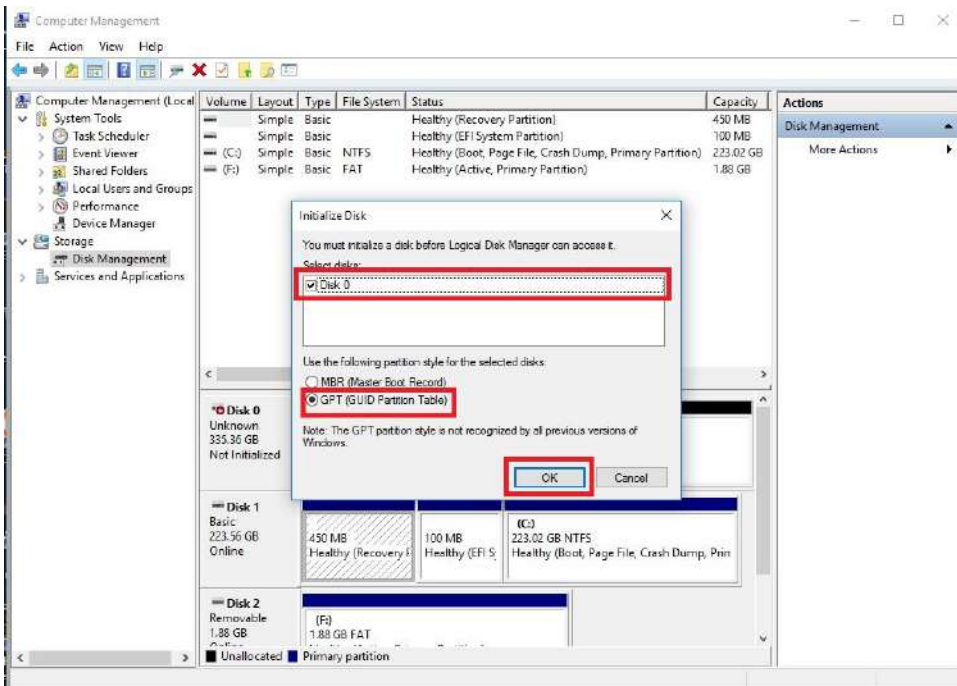

Before you can assign a drive letter to a drive or array, the initialized disk must be partitioned. If you are following this guide and just initialized your drive or array, the New Simple Volume Wizard will automatically pop-up.

If your drive or array is initialized, but not partitioned, the disk will appear in Disk Management as “Unallocated,” as shown in the image below. Right-click on the box containing “Unallocated” and select “New Simple Volume” (this text may vary slightly based on operating system). The New Simple Volume Wizard will pop-up.

When the window below opens, click “Next.”

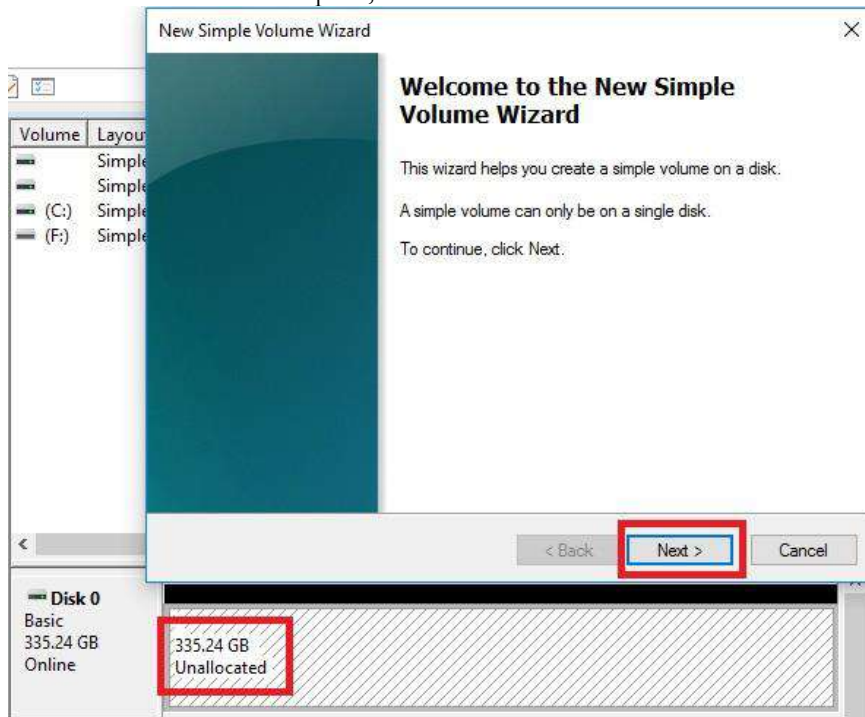

Leave the size at default to create a partition using the entire volume of disk space, then click “Next.” Select the drive letter you want to represent this drive, then click “Next.” Note: The drive letter does NOT have to be a consecutive letter with previous drive(s). Also, the wizard will not allow you to accidentally select the letter of a drive in use.

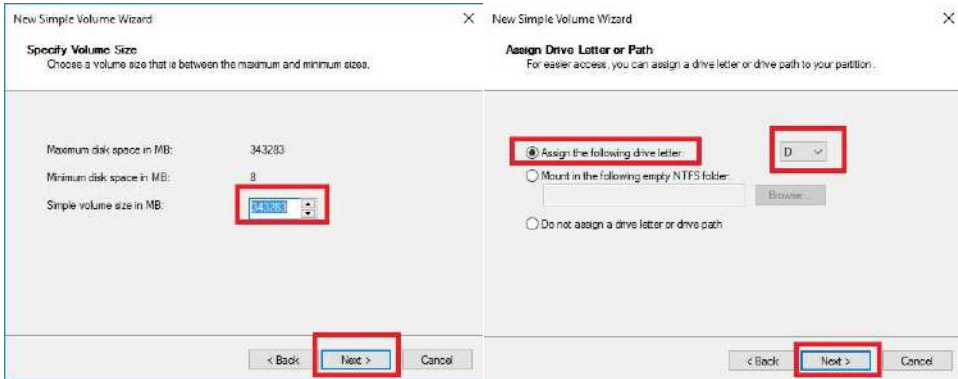

The next step is to format the partition. Select your File System; NTFS is default, and generally recommended for most large drives. Check the box for “Perform a quick Format.” You may rename the volume, or leave it at default. Click “Next” when ready.

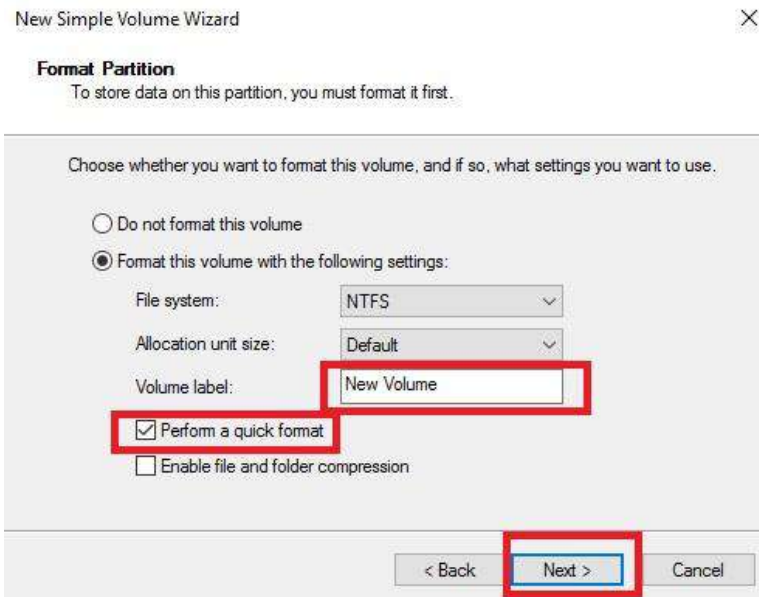

After the quick format is completed, you will see the last Window of the wizard, a summary of the process, then click “Finish.” The drive is now usable.



To confirm, go back to File Explorer in Windows. Click on “This PC” and check the drives section. You should have a new empty drive there, with the letter you designated.

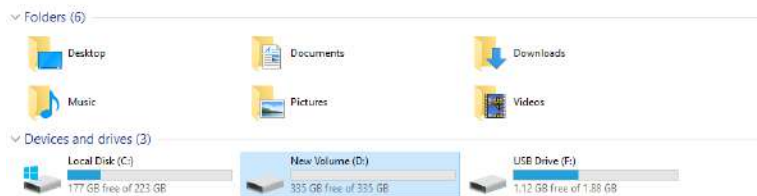

At this point the process of building an array and making it usable is completed.



## Fan Header DC and PWM setup

The Z390 DARK supports both 4-pin PWM fans and 3-pin DC fans. The motherboard uses eight 4-pin fan headers, including 2x CPU FAN (PWM), a CHA FAN (PWM/DC), a PWR FAN (PWM/DC), 3x SYS FAN (PWM/DC), and an AUX FAN (PWM/DC). You can locate each header on Pages 14 and 15, component numbers 3 and 4.



To configure the fans in BIOS/UEFI, first power on / restart the PC. During the POST sequence, press [Delete] repeatedly to get into the BIOS. Once in the BIOS, use the arrow keys or your mouse to navigate, whichever is easier, and make your way to the “Advanced” – “H/W Monitor Configuration” menu.



Once into the H/W Monitor section, you can see the temperature monitors across the top. Below the monitors, each fan is already configured in Smart mode, which means the fan controller is using a Smart curve for fan controls. Each fan can be set to a separate fan curve. To set a Smart curve, please see the guide starting at the top of the next page.

The +/- buttons next to Smart allow you to set your fans at a static speed percentage, instead of a curve. If you set the speed too low, however, the fan may stall; the stall speed will vary from fan to fan.

Below the fans, you will see the six (6) PWM/DC fans: SYS\_FAN1, SYS\_FAN2, SYS\_FAN3, CHA\_FAN, PWR\_FAN, and AUX\_FAN. The fan controller will automatically detect and set the fan to either PWM or DC.

Alternatively, the PWM/DC fan headers can be set to either PWM Mode or DC Mode, which can be selected by clicking on the pulldown menu. DC Mode will power the header using the static percentage set and the fan's maximum speed. PWM Mode will power the header and communicate via pulse with a supported PWM fan.

PWM mode is necessary if you are running a PWM fan powered by a different connector, such as a molex, SATA, or 3-pin header not on the motherboard. If you don't select PWM mode in this scenario, the fan may run at 100%, or behave erratically, regardless of the Smart Profile or percentage that you set above.

To set a Smart curve, select the “Smart Fan Settings” and enter the menu.

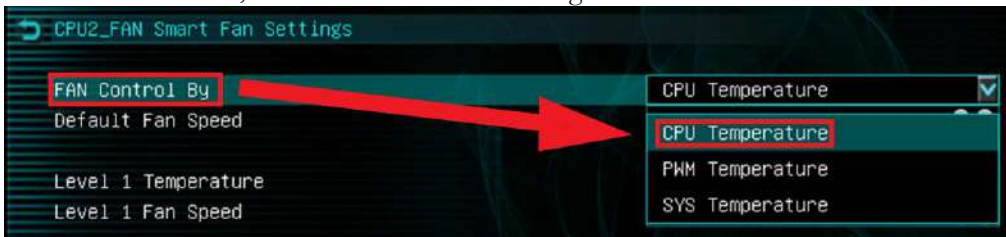

First, choose the temperature monitor the PWM controller will use to monitor for its temp information. It's recommended to link the fan control to the CPU, which is predominantly the most important temperature in the system. The exception is when you have 32GB of heavily overclocked RAM, which may cause PWM temps to be a concern. If this is a concern, set the fan control to the PWM temp.

Once you've set the Fan Control reference point, you can set the Default fan speed. The fan speed will increase once the temperature reference point has heated up enough to hit the Level 1 Temperature. Once it hits the Level 1 Temperature the fan controls will override the Default speed setting based on the temperature at the time.

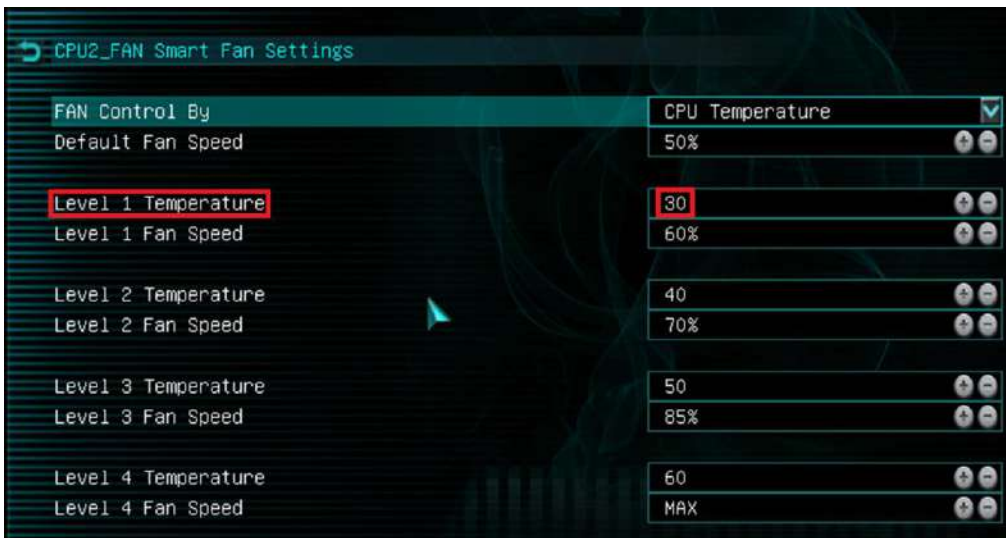

There are four tiers of temp control, with Level 4 fan speeds generally recommended to be set at Max. The example above uses a fairly aggressive fan curve, but you can set this as high or low as you wish. Make sure, however, to stay below 5-10C of the Max safe load temp for your specific processor, which can be found at [Ark.Intel.com](http://Ark.Intel.com). All Smart Fan Settings have the same controls and can be setup the same way.

When monitoring temperatures vs. fan speed, you may notice a variance in ramp up/down temps; this is due to a function EVGA hardcodes into the BIOS called Hysteresis. Hysteresis builds in a buffer to control fan speed behavior. This feature prevents a constant ramp up/down from happening when your system sits exactly at the temp you set for SMART fan controls. For example, if your setting is at 30C and you hit 31C, the fan will ramp up and cool down to 29C, letting the fan slowdown, which lets the system heat back up to 31C again, repeating indefinitely and causes the system to sound like it's breathing. Hysteresis adds a 4C +/- buffer for CPU and PWM, and 2C +/- for SYS. This means that once a fan based on the CPU or PWM temp brings you down to 30C, it will not ramp back up until 34C, so you have a buffer. If you base the fan control on the SYS temp, you will only see 2C variance.

# Setting Up SLI and PhysX

SLI and PhysX are NVidia developed technologies supported by EVGA motherboards. SLI is a means of dividing the graphical load between multiple video cards, similar in theory to how dual- or quad-channel memory works, or even how RAID0 works. However, the software (e.g. game) needs to support SLI to gain from this technology.

PhysX is an NVidia technology that can be assigned to a graphics card or CPU for programs supporting NVidia PhysX. As long as the PhysX driver is installed, which occurs during a normal NVidia GeForce driver installation, the system will allocate resources to support PhysX based on CPU or GPU load. You may, however, go into the NVidia Control Panel and dedicate the CPU or a GPU to this function manually. For a complete list of NVidia PhysX supported titles, please see this link:

<http://www.geforce.com/hardware/technology/physx/games>.

SLI requires two or more video cards that support SLI; have the same GPU family (GTX 1080 Ti, GTX 480, etc.); have the same memory type (GDDR5, GDDR5X, etc.), volume (3GB, 8GB, etc.), and datapath width (128bit, 256bit, 384bit, etc.). SLI also requires a motherboard that supports SLI and an SLI bridge for the gold fingers of each card in SLI. Providing the above conditions are met, compatible graphics cards with different GPU and/or memory clock speeds will not prevent SLI from being enabled.

**Note:** For questions and concerns regarding NVidia Surround™ and full setup instructions, please see <http://www.geforce.com/hardware/technology/surround/system-requirements>. As the possible combinations of setups between SLI, monitors, and cabling are far too vast to label in this manual, also see <http://www.geforce.com/whats-new/guides/how-to-correctly-configure-geforce-gtx-680-surround> for a basic setup walkthrough.

Installation:

1. Physically install your graphics cards, then install a SLI bridge; examples include a Flexible bridge (included with this motherboard), an EVGA Pro Bridge, or an EVGA HB Bridge. Current NVidia graphics drivers support 400 Series Fermi cards up through GTX 1080 Ti and Titan XP cards. Driver support is determined by NVidia; please check GeForce.com to confirm compatibility with drivers and SLI.

Once the graphics cards are physically installed, connect an SLI Bridge; your cards should look similar to either picture below:



2. After the cards are installed, have power connected, and the SLI bridge attached, boot into Windows. The graphics driver will normally identify the cards and automatically configure the driver. If not, then you may need to reinstall the driver.

Once finished, you will receive a popup in the lower right corner stating that you have an SLI capable setup and it needs to be configured. If you did not see the message, then first verify that both cards are detected and functioning without system errors from Windows Device manager.

Right-click on the Start menu and select Device Manager.

Under “Display Adapters” you should see the type and number of video cards you have installed.

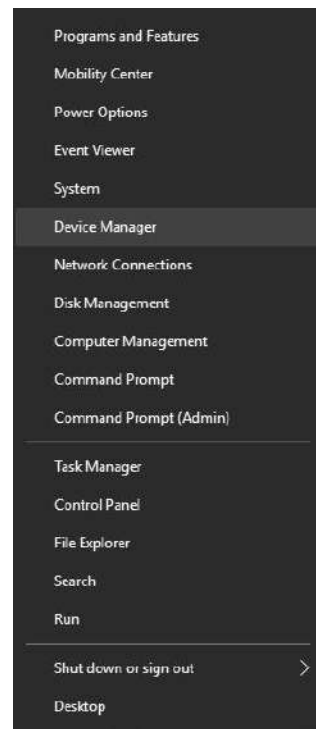

3. Once you have verified there are no detection/driver installation issues with the cards, you can enable SLI. Right-click on the desktop and select “NVIDIA Control Panel” (“NCP”).

Next, select “Configure SLI, Surround, PhysX” under the “3D Settings” menu. The default is “Disable SLI.”

To enable SLI, click “Maximize 3D Performance,” circled in red below, and click “Apply” at the bottom.

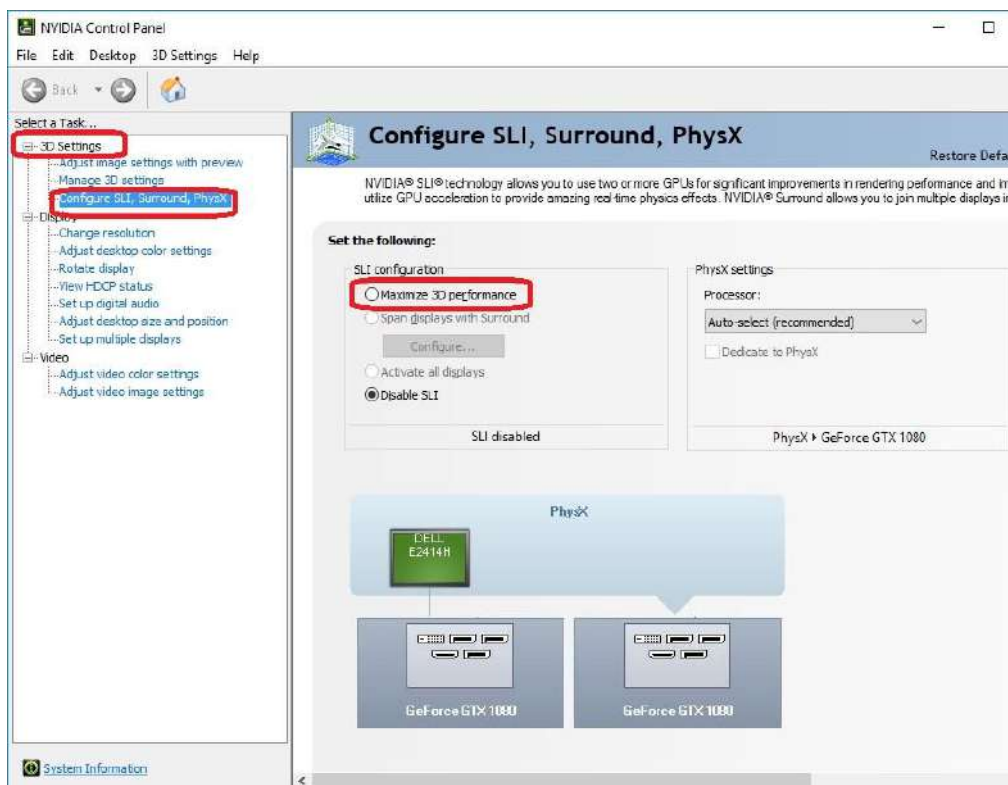
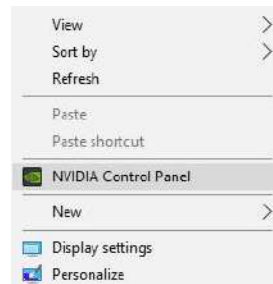

Before you can enable SLI, the NCP may ask you to close certain programs and processes; you cannot continue further until this is completed.

At this point the display may go black a few times, or appear to change resolution and back again quickly; this is normal. Also, if you are running a G-Sync monitor, it will turn off and on during this process, which may take between 5-20 seconds, approximately.

4. Once finished, your SLI configuration should look similar to the image below. The key aspects that show all is well are circled.

5. OPTIONAL. With multiple cards, you can assign one to PhysX, but we do not advise choosing that OVER SLI, because SLI will provide substantially larger performance gains. In general, leaving PhysX on “Auto-Select (recommended)” is recommended. When left on Auto, your PC will adjust the PhysX duties based on overall system load, which, in many cases, will be the CPU. Otherwise, manually setting the PhysX processor is best when a spare graphics card is in the system.

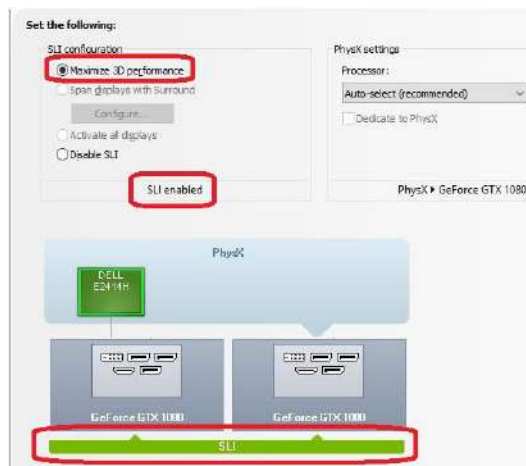

While SLI is a direct performance enhancement PhysX is used for visual enhancement, allowing the physics of various items in the environment to be calculated live. A dedicated PhysX card keeps the load localized to a device that has no other current function. Although frame rates may only increase slightly, a dedicated PhysX card keeps the frame rate from spiking in either direction when there are very intense and abrupt uses of PhysX. For certain titles that heavily utilize PhysX, a dedicated PhysX card can be beneficial to help stabilize the frame rate.

If you do not have a spare card to dedicate to PhysX then it is advised to leave the PhysX Setting to "Auto-Select (recommended)." The general rule of thumb for needing dedicated PhysX is this: Does your game support NVidia PhysX? (Yes or No). If “No,” then a dedicated PhysX card serves no purpose. If “Yes,” then the next step is to see if your GPU has a high usage rate while playing normally. Use a program like EVGA Precision XOC to monitor the GPU usage of all current video cards. If the GPU is consistently over 75% usage, the GPU usage occasionally maxes out and the frame rate drops in moments of intense action, then dedicating a card may be beneficial. However, if this does not occur in your setup, then leaving your system to handle the PhysX load without a dedicated card should be fine, since the default setting will balance the PhysX processing between the GPU and CPU based on load at any given moment.

If you need further help setting up SLI/PhysX, please contact EVGA Customer Service.



## Creative Labs Sound Blaster Pro Studio

The Z390 DARK uses a 5.1 Creative Labs CA0132 audio controller. This section will cover installation of the controller (in Windows 10) and the basic configuration options that are available in the software.

To begin, use your installation DVD or download the current Creative drivers from [www.evga.com/support/download](http://www.evga.com/support/download). Once the zip file is downloaded, extract the folder. Open the “Creative” folder, go into the “Audio” folder and launch “Setup.” Once launched, select “Next” on the installation window, select “Modify,” then click “Next.” The install options for software components will appear, and click “Next” when you’re ready to proceed. \*Note\*: Depending on your version of Windows and/or installed software, you may only have the option to Install the Sound Blaster software, rather than Modify, Repair, or Remove.

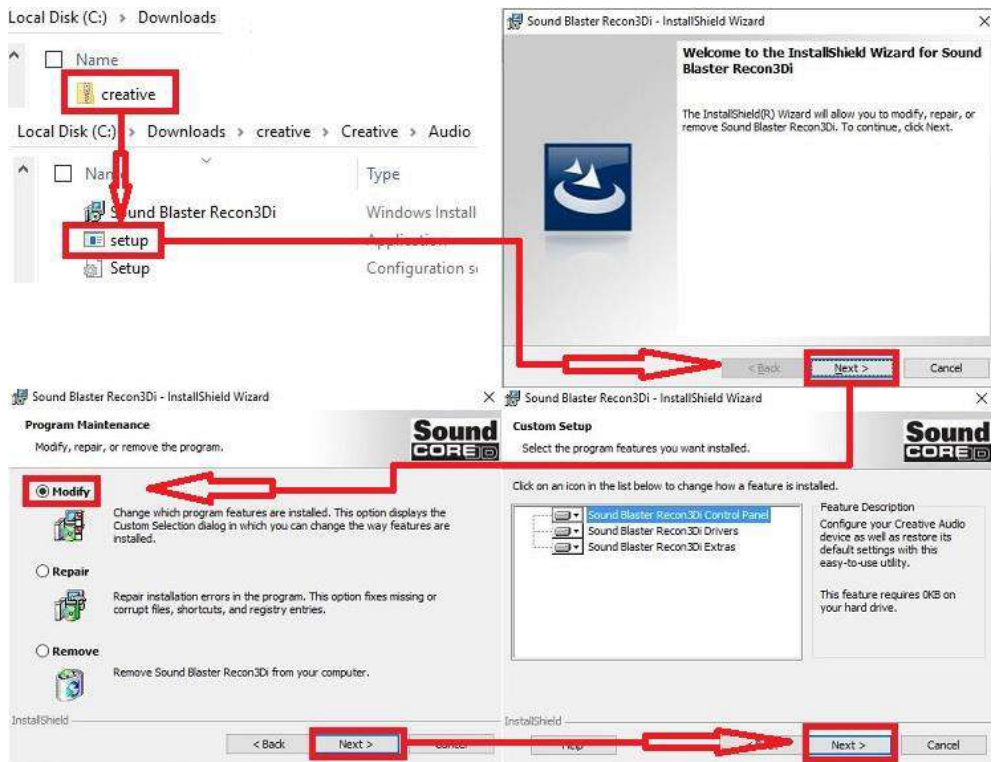

You'll have one last prompt to go back and make any last minute changes before proceeding with the installation. When ready, click "Install" to begin the installation with the selected options. Once the install process is complete, click "Finish." A final window will pop-up informing you that the installation is complete and prompt you to reboot to complete the installation.



Once you have rebooted and re-entered Windows, there should be a new shortcut in the system tray with a Blue-Green box around SB. When you mouse over the icon, it reads "Sound Blaster Recon 3Di Control Panel." Left-click on the icon, and the Sound Blaster suite will launch.



The below images are all composites, showing the tooltips for multiple buttons and menus on screen at the same time to reduce picture clutter; your experience will differ, as each button and panel must be hover at individually to see the same tooltips in the Sound Blaster Recon 3Di Control Panel.

Once the Pro Studio software is open, you can configure several aspects of your audio.



The “SBX Pro Studio” is the first section on the left menu bar. The SBX Pro Studio is a virtual studio that will take your audio source, simulate the effects based on your settings, then outputs the resampled audio to your speakers. Disable the SBX Studio if you prefer the natural sound of your audio. Please see the next page for an image of this section.

At the upper-left of the Pro Studio area is the On/Off for the SBX controls. It is on by default, and must remain on to use any of the available SBX options.

“Surround” can be enabled or disabled. SBX Surround provides immersion control to enhance the natural sense of audio depth and spaciousness by creating virtual surround sound channels. Stereo content or multi-channel content played over stereo speakers and headphones will sound as if it's coming from all sides while voices remain centered in front and original balance and timbre is preserved. The effect is simulated by remixing the audio source based on the virtual speaker configuration, adjusted by the slider bar. If you have a quadraphonic or 5.1 speaker configuration, this setting is unnecessary for surround; however, this setting can enhance the effect. The “Test” button plays an audio file with surround features to help you adjust the slider until you are satisfied with the surround effect. This setting is essential if you are trying to use a stereo configuration (i.e. headphones) with simulated surround (i.e. for gaming).

“Crystalizer” enhances the dynamic range of your compressed audio source to give you a more realistic experience. When audio is compressed, it loses some data around the high and low frequency range. Crystalizer simulates some of the lost data to restore the lost dynamic range to enhance the sound, often enhancing percussive sounds. Move the slider bar to the left to lessen the effect, and move the bar right to increase the effect.

The “Bass” setting fills in the missing low frequency tones and gives the extra impact for a better entertainment experience. This does not change the bass source, but rather

amplifies it. A subwoofer is not necessary, but the quality of your audio equipment will determine how far you can raise the slider before the audio becomes distorted

“Crossover Frequency” should be adjusted based on your audio equipment. This setting controls the frequency cutoff for speakers and subwoofer. To properly adjust this setting, please see the guide for crossover frequency on Page 110.

“Smart Volume” addresses the problem of abrupt volume level changes during audio playback by automatically and continuously measuring volume, and intelligently applying gain and attenuation to compensate for those changes. This helps to reduce the sudden dips and spikes in volume in order to sustain a narrower decibel range. In other words, it will “chop off” decibel levels higher and lower based on the range specified by the options. There are three presets and each can be adjusted using the slider. “Normal” keeps the volume skewed towards a centered decibel level. “Loud” skews the volume towards a higher decibel range. Finally, “Night” skews the volume level towards a lower decibel range.

The last check box is “Dialog Plus.” This volume control amplifies voices to make dialog clearer in the midst of other audio content, including music, action sounds, or other ambient noises.

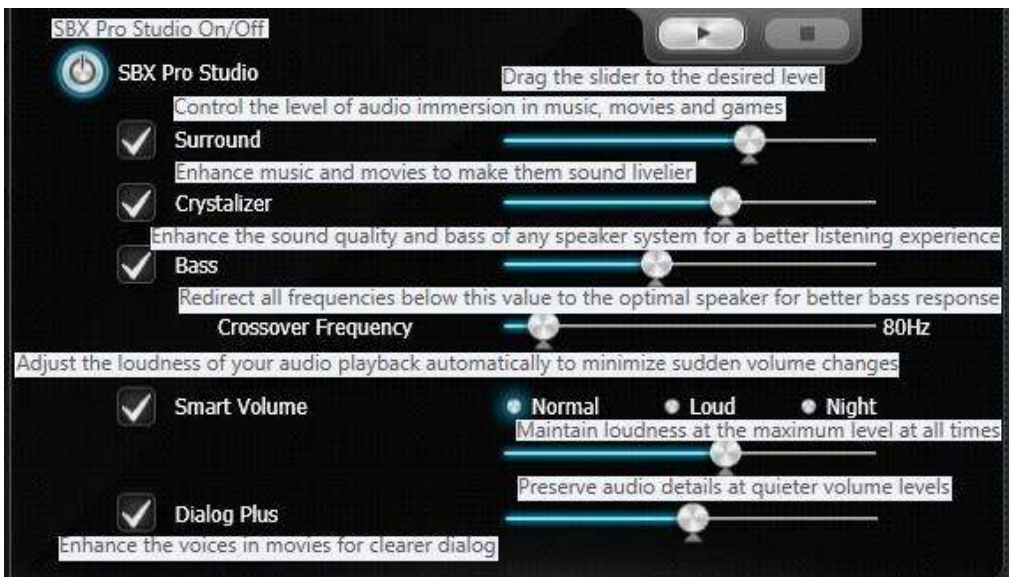

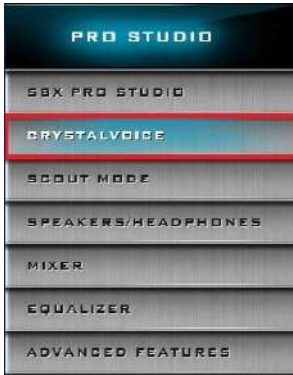

The next section is “CrystalVoice,” which covers microphone controls. Using the image to the right, the pulldown menu displays the current default recording, and allows you to switch between other connected recording devices, if present. The upper-right button, outlined in red, allows you to select whether the recording



Select a recording device

Microphone (Unplugged) [Dropdown] [Menu Icon] [Set as Windows default]

Mic Recording Volume [Slider] 81%  
Drag the slider to the desired level

Mic Boost [Slider] +30dB  
Drag the slider to the desired level

CrystalVoice  
CrystalVoice On/Off

FX Morph your voice into different characters and accents  
Neutral [Dropdown]

Smart Volume [Slider] 74%  
Be heard clearly without having to shout or whisper  
Drag the slider to the desired level

Noise Reduction Eliminate unwanted background noise in your conversation

Acoustic Echo Cancellation Eliminate echoes that interfere with your conversation

Note: Only the selected microphone will have the CrystalVoice effect. [Test]

device is a Rear Microphone or Line-In device.

The CrystalVoice menu can be enabled or disabled by clicking the On/Off button. If you prefer the sound of your recorded voice without enhancement, leave this off.

Mic Recording Volume adjusts the level of volume that will be picked up by the mic – including background noise – and played back to listeners or captured by a recording. This setting is the easiest way to make quick adjustments to your voice level.

Mic Boost is used to increase the gain of the recording device. Whereas Mic Recording Volume is more of a fine-tune option for volume, Mic Boost is designed to make sure you're at the correct volume level to allow for fine-tuning.

“CrystalVoice,” similar to the SBX above, enables the voice tools in the lower section. Similar also to the SBX, disable this if you prefer the natural sound of your recording audio rather than utilize the features.

“FX” will be covered on the next page.

“Smart Volume” automatically adjusts the loudness of the speaker's voice to maintain a consistent volume level. This makes it convenient for the speaker to converse normally, regardless of whether the speaker is close to or far away from the microphone.

“Noise Reduction” is used to help filter out background noise such as other voices, fan noise or any other ambient sound that a mic might hear.

“Acoustic Noise Cancellation” is used to eliminate echoes and enables your listener(s) to hear you more clearly. Enabling this setting will cut down on audio artifacts caused by proximity to walls or unusual room acoustics, as well as noise picked up from your front speakers.

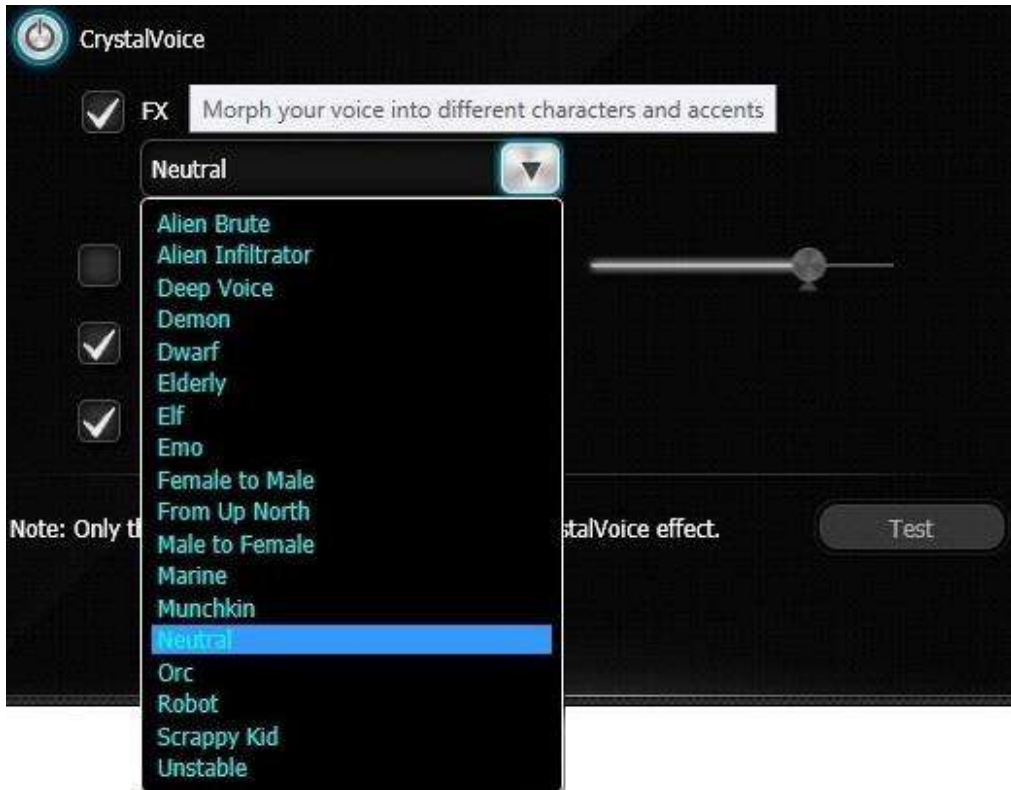

CrystalVoice FX enables the speaker's voice to be altered with a variety of effects, which can be used to enhance the tone of the speaker's voice, create interesting accents, or to sound like a completely different person.

The "FX" checkbox enables several preset voice modifications. Neutral will leave your voice as it naturally sounds (this is the default option while you have the FX box checked); all other options from the pulldown menu will modify your voice based on their settings.

Needless to say, this feature is designed to have fun with the person to whom you are speaking. Neither Creative nor EVGA guarantees that you will actually sound like any of these options.

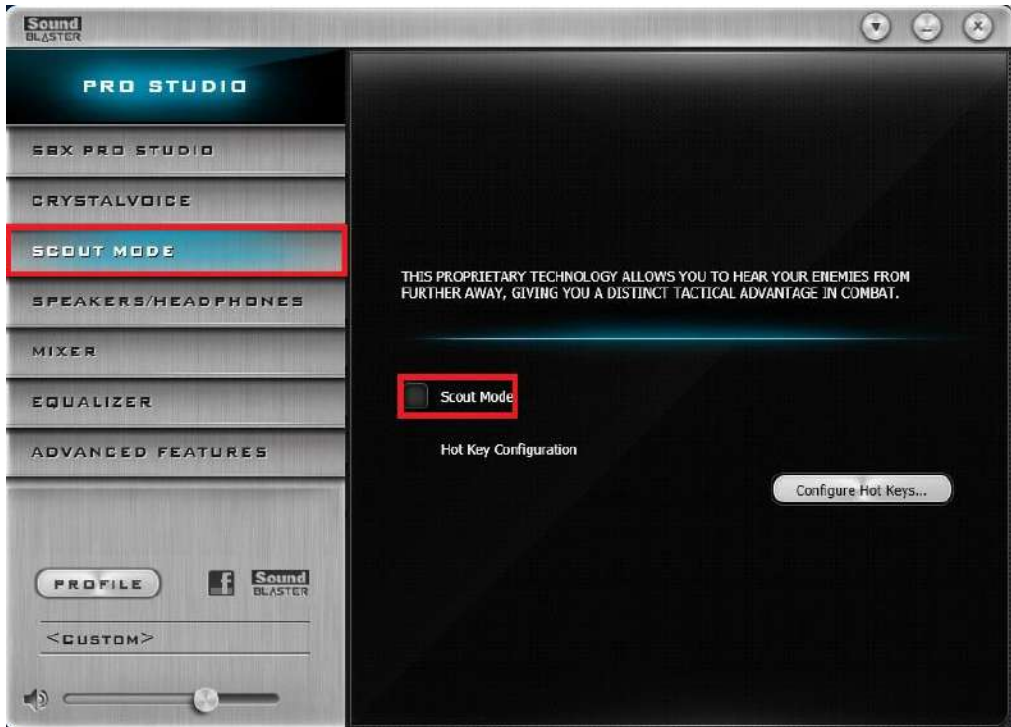

Scout mode is a setting specifically for video games and, more specifically, first-person shooters. Enabling Scout Mode will reduce the sound from music, voices, explosions, etc. and amplify the sounds of footsteps, brush, and ambient noises without raising the overall volume. This setting is specifically meant for an advantage in competitive play. It is NOT recommended for RTS/TBS games, RPGs, TV/Movies, or anything else where you would prefer an immersive experience.

Creative added the option to configure Hot Keys to enable/disable this feature. Even if you enjoy using this feature, you may not want to keep it enabled the entire time you are playing, or you may prefer to use it only in certain circumstances. By creating a Hot Key configuration, you can quickly enable or disable Scout Mode without leaving your game.





The “Speaker/Headphones” section will provide configuration options for Speakers in a 2.0/2.1, 5.1 Surround, or Headphones. Please review the Component Legend on Page 16 to make sure you connect your audio device(s) to the correct port(s).

At the top, you’ll notice a slider bar for Speakers or Headphones. This option only has two selections, and switches between your Speaker and Headphone settings. You’ll also see a pulldown menu, which features Headphones, 2.0/2.1 and 5.1.

Selecting Headphones from the pulldown menu switches the slider at the top to use the headphones port; selecting 2.0/2.1 or 5.1 switches the slider at the top to Speakers, to use the speaker ports. Although headphones can be plugged into either the Light Green or DARK Green port, it is highly recommended to use the DARK Green port, as this enables certain features to be configured properly for headphones (e.g. SBX Surround).

By default, the selected speaker option is 2.0/2.1. This setup requires your audio device to be plugged into the Light Green port. The only configuration option provided for this setup is whether your speakers are Full-Range.

Speakers either fall into full-range or component speakers. Despite the speaker icon switching between large and small when the full-range option is enabled or disabled, respectively, actual speaker size has little to do with whether they are full-range or not.

Full-range speakers are designed using drivers that can independently output audio across a wide frequency response of 20Hz-20,000Hz +/- 3dB at the same volume level. When this setting is enabled, Creative will disable its crossover filter and send the full frequency range to the speakers, whereupon the speakers will engage its own hardware crossover filters to appropriately direct audio to the individual drivers.

If your speakers are not full-range, they will not have necessary hardware components to play low frequencies, nor are they designed for that purpose. When the full-range option is unchecked, the Pro Studio will instead send the full-signal out using crossover filters or, as the Pro Studio calls it, bass redirection. This sort of signal will send out the full audio frequency such that the majority of the frequency will go to the speakers, but direct the low frequencies to a subwoofer. This way, you’ll still get the same sound, but you must select the correct options.

To determine if your speakers are full-range or not, you must look at the minimum frequency response of your speakers. The concern is not the high-end of the frequency response, but rather the low-end. As noted above, if your speakers are not rated for a minimum of 20Hz, then they are not full-range speakers. Here are some considerations:

- Assume your speakers are not full-range. Modern speaker design uses a subwoofer to handle the relatively small percentage of content you hear in an audio signal. Low frequency content, more commonly known as sub-bass, is greatly amplified by the subwoofer, which explains why the smallest percentage of your audio content can often be the loudest. The subwoofer allows the speakers to concentrate on the remaining 99%+ of the audible frequency bandwidth.
- Generally, if your speakers came with a subwoofer, they are not full-range speakers. As noted above, subwoofers are designed, in part, to allow speakers to stay clear of the low frequencies. When examining the specs of the speakers, make sure to look at the frequency response specifically of the speakers, and not just the specs of the speaker system. Sometimes, the most easily available specs may include the subwoofer, which can go as low as 18Hz +/- 2 dB; the minimum frequency of the speakers, however, may be much higher.
- If you have a 2.0 stereo setup, look for the frequency response specs. If they do not have at least a 20Hz to 20kHz range, then they are not full-range speakers. You may try full-range, but you will lose any audio data below the minimum frequency of your speakers or may hear distortion at lower frequencies.
- Headphones tend to be full-range speakers, as they are designed to operate without a subwoofer. However, the quality of your headphones will determine whether you should configure them as full-range or not.
- If you use a receiver or your speaker system is run through your subwoofer, do not use the full-range setting in the Creative panel without consulting the instructions for your receiver or speaker system, since it's possible that your audio system prefers to be set to full-range, so that the receiver or speaker system will utilize its own crossover settings once receiving the full audio range.
- Lastly, audio equipment quality will have the greatest effect on whether you should set full-range, or not. Very few speakers are properly designed for full-range audio, and if they are, then they will likely be very expensive.

Two last considerations: First, do not set Headphones to full-range if using the SBX Surround option, as Surround will not work properly in full-range mode. Second, do not enable full-range mode for 5.1 audio or the bass redirection will not work properly. The only exceptions to 5.1 and full-range is that you either 1) have a full or partial set of

full-range speakers in your setup, or 2) you are using a receiver or speaker system that prefers to handle the low frequency crossover at the receiver or speaker system, rather than using the Pro Studio to configure the crossover settings for low frequencies.

Below is the example of both standard and full-range speakers. When Full-Range is checked, the speaker icons enlarge to show full-range is enabled.

The “Test” button at the bottom will play sounds from both satellite speakers to ensure they are functioning properly, or you can click just one to test that specific speaker.

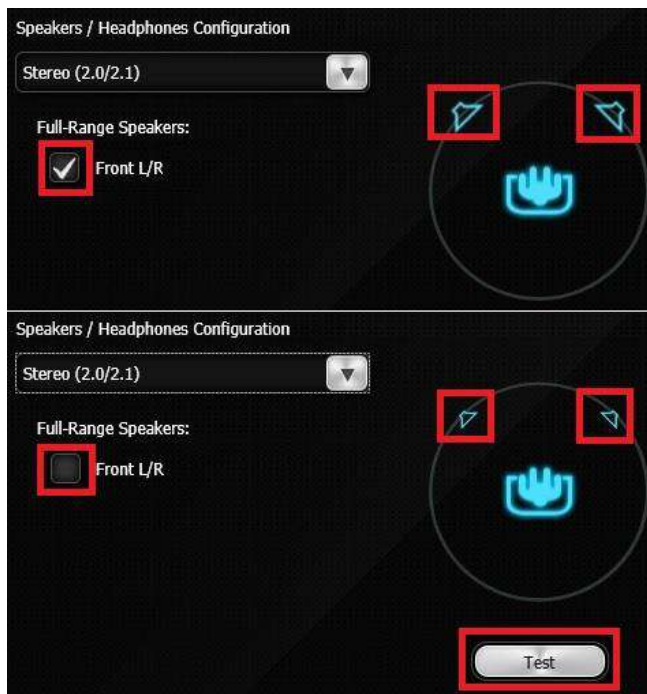

In 5.1 mode, you can toggle the center channel, subwoofer, and rear satellite speakers on and off from this menu. If any of the satellites are disabled, the sound readjusts to ensure you receive full sound, albeit balanced through the selected speakers.

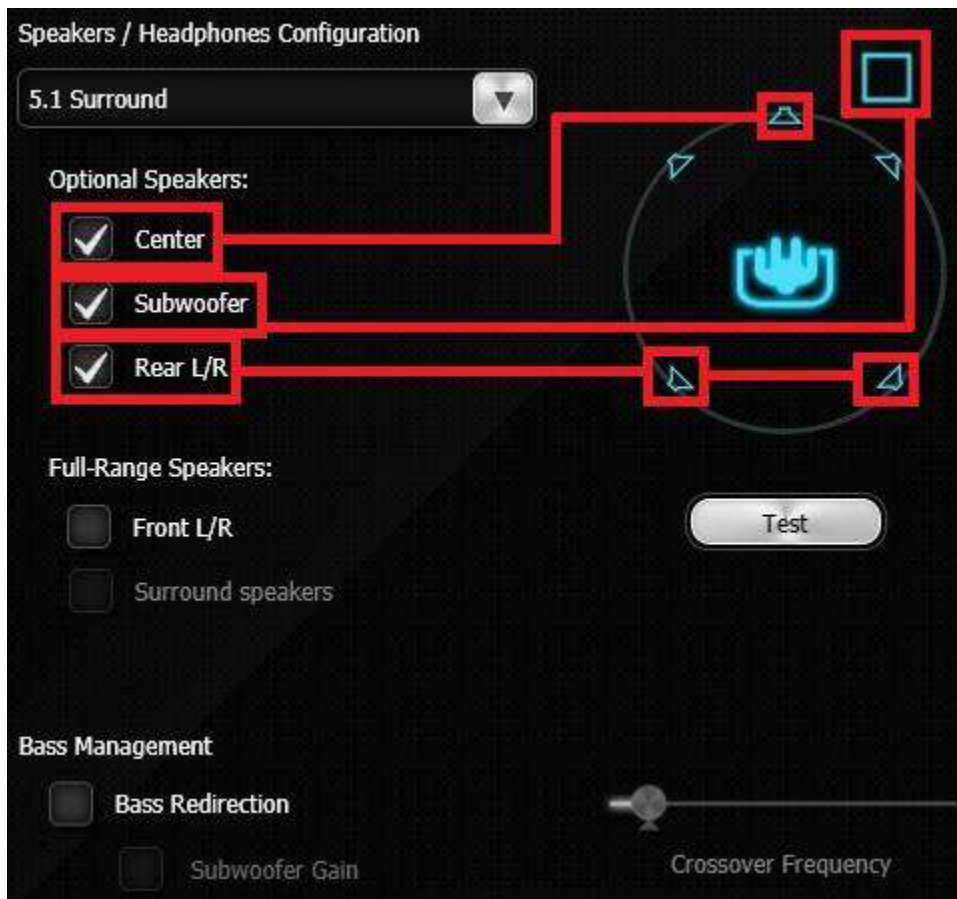

In the lower section there is an option for “Full-Range” speakers. You must set the front speakers to Full-Range before the Full-Range option becomes available for Surround speakers. If you are unsure if your speakers are full-range or not, please see the previous section on Page 106.

As in the previous section, enabling Full-Range will show the speaker icon larger than when disabled. In the images to the right, you’ll see the three options for full-range speakers illustrated.

The top image shows a 5.1 system with no full-range speakers enabled. The middle image shows only the front channel in full-range mode and the satellites and subwoofer in standard mode. Lastly, the bottom image shows the entire surround system in full-range mode. The checkboxes enable them, and the visual differences in the speaker reference will show at a quick glance which are actively in full-range mode.

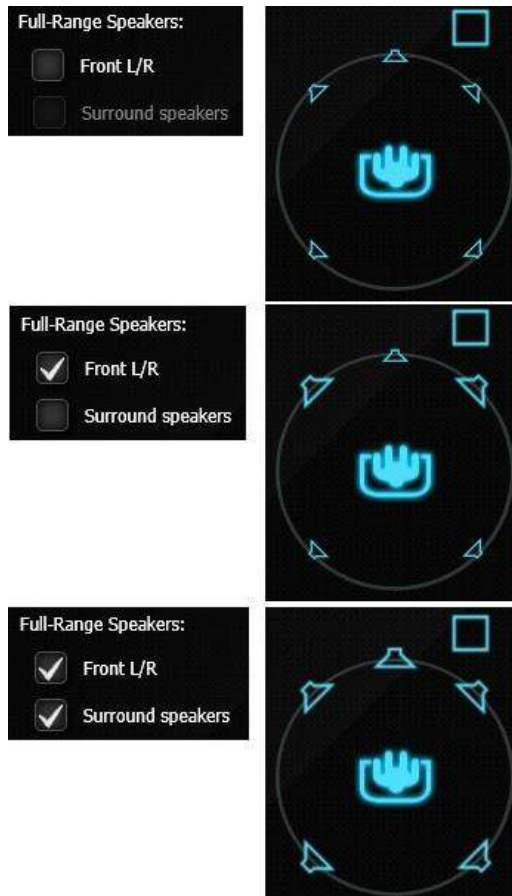

The last section is “Bass Management.” Clicking on “Bass Redirection” enables the Crossover Frequency slider to balance what goes to the subwoofer and satellites. This setting generally will not provide much benefit to headphones, because the bass redirection occurs inside the headphone through its own crossover filters.

On a system that does not use full-range speakers, this is a crucial setting for ensuring that your speaker system correctly plays low frequencies. The default frequency is set to 80Hz, but your system may need adjustment.

To properly set the crossover frequency, look at the specs for both your speakers and subwoofer. Some pre-assembled speaker systems may tell you what to set the crossover frequency to in your instruction manual. If not, then look for the minimum frequency response of your speakers (i.e. 75Hz, 80Hz, 175Hz, etc.), and the maximum frequency response of your subwoofer (i.e. 60Hz, 80Hz, 120Hz). Once you have that information, you can set the crossover frequency.

Ideally, you'll want to make sure that the crossover settings provide enough room to set the crossover frequency a little higher than your speakers' minimum frequency response, which will reduce distortion and provide a smoother transition to your subwoofer. A good rule of thumb is to set the crossover frequency about 20Hz higher than your minimum speaker frequency response. However, you may run into three different scenarios:

First, the frequency response of your speakers (e.g. 60Hz) and subwoofer (e.g. 100Hz) nicely overlap. This is ideal. Using the general rule above, you would set the crossover frequency to 80Hz and call it a day. You should still test the audio to ensure it is free of distortions, but this provides enough room to pass the low frequencies to the subwoofer and keep the higher frequencies to the speakers, without creating a conflict.

Second, the maximum frequency response of your subwoofers is exactly the same as the minimum frequency response of your speakers. In this case, you must set the crossover frequency exactly to where the subwoofer and speakers meet.

Third, you may have a situation where your speakers' minimum frequency response (e.g. 100Hz) is higher than your subwoofer's maximum frequency response (e.g. 80Hz). This should only happen if you purchased the subwoofer separately from the speakers. This setup cannot work properly, and you must replace either the speakers or subwoofer. Although you can adjust the setting to either the subwoofer's maximum frequency response or your speakers' minimum frequency response, you'll lose the audio data between those frequencies.

The last option is "Subwoofer Gain." When enabled, there will be significantly more bass and subwoofer volume. This is a simulated gain, so you may find increased distortion based on the amount you set, and the quality of your subwoofer.

As with any speaker or microphone setting, your audio equipment will have a significant effect on audio quality and effectiveness of multiple settings. For example, some microphones already equip some degree of noise or echo cancellation and do not benefit further from Creative's CrystalVoice options. Likewise, even for microphones that do not have built-in noise or echo cancellation, Creative's cancellation effects may create distortion or other audio problems. Similarly, two different sets of speakers or headphones may require vastly different settings to provide the best sound quality for a given game or type of music. This guide will help you to get started and understand the basics of getting around the Creative control panel, but it will be up to you to test your own equipment to determine the effectiveness and usefulness of the various settings outlined above in the Creative Sound Blaster Pro Studio guide.

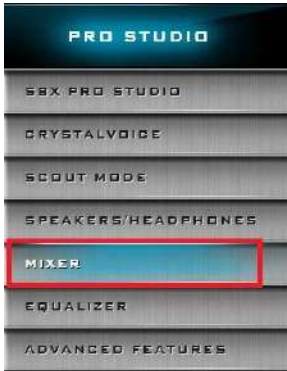

The Mixer section is where you can control volume levels, balance, input jacks, stereo volume for all input and output devices, and master volume for all sections.

The top setting is “Speakers,” which is the Windows main volume; this is the same control attached to the system tray speaker icon for every Windows-based PC. Click the gear icon to the right of Speakers to open the controls for the individual satellite components.

The second option down is “SPDIF-Out.” This slider will control master S/PDIF volume for the optical out component on the IO Hub, which is a header dedicated for attaching a receiver, TV, or sound bar. Click on the gear icon

to the right to open the option for left and right channel volume balance.

The third component down is the “Input Device” icon, which allows you to configure the Rear Input Device.

The last selection under Recording is the “What you hear” slider, which is the master volume for Creative’s stereo mix recording feature. This feature is separate from microphone settings.

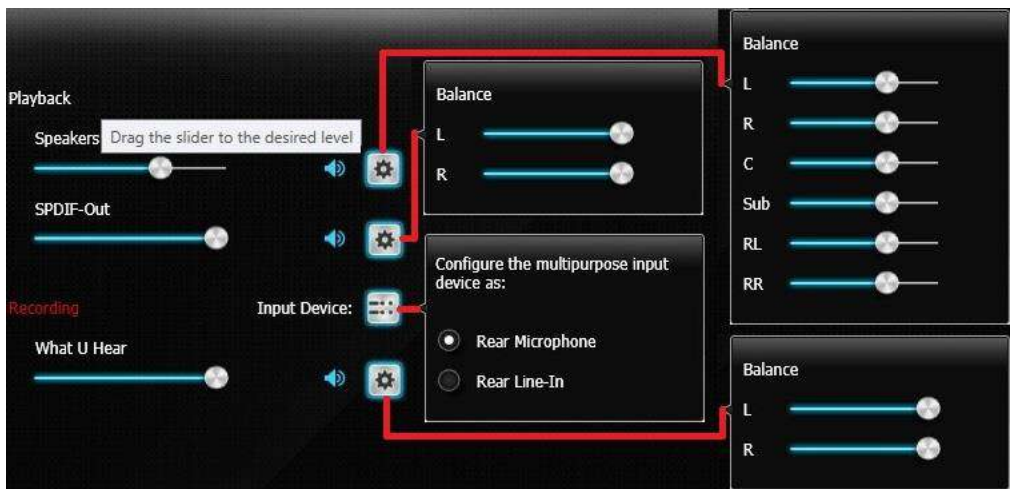





The “Equalizer” section provides a software-based EQ with several preset built-in tools to manually to make custom balances for any type of music, game, or movie. By default, the equalizer is disabled, leaving all frequency bands at a median.

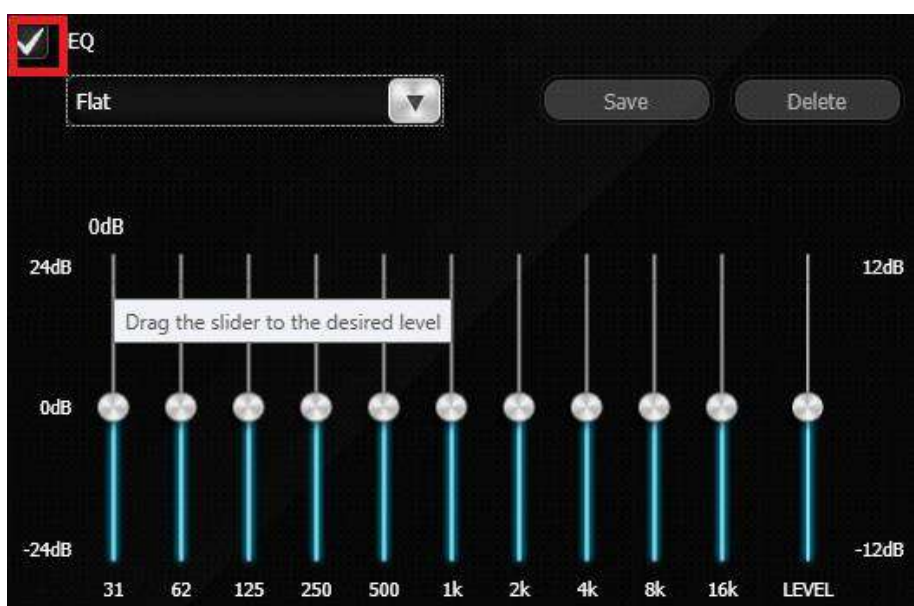
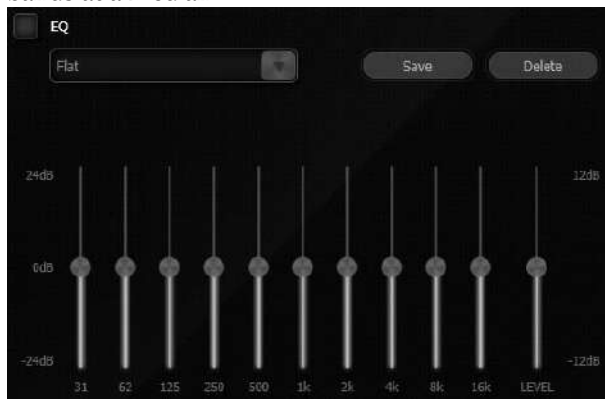

Click on the “EQ” button in the upper-left corner to enable the “EQ” functionality.

Once enabled, the pulldown menu for EQ presets and manual controls becomes available. The default EQ setting is “Flat,” which means no specific optimization. There are 10 EQ presets to choose from. We recommend testing to see how accurate they will be for your specific audio system, since the presets are meant to be compatible with a wide range of audio devices.

If you opt to make a custom profile, adjust the sliders to fit your sound system and audio preferences. Enter a profile name, then click Save.

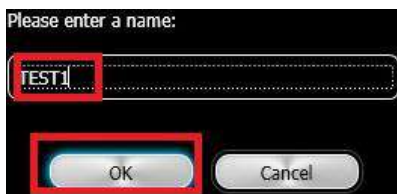
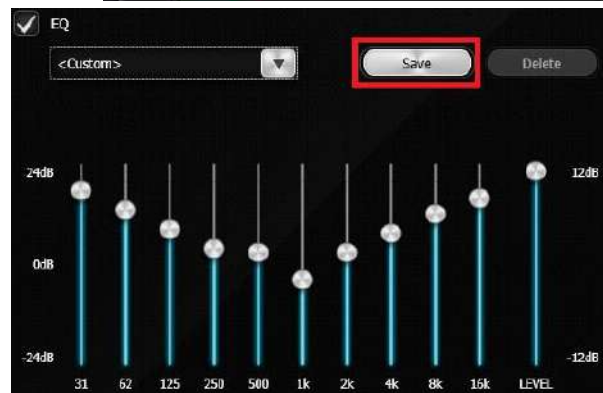

After the profile has been set, named and saved, the profile will now appear in the pulldown menu for use; see the image to the right. The selection will go into effect instantly, as soon as you select a new EQ mix even if there are music, movies, games running.



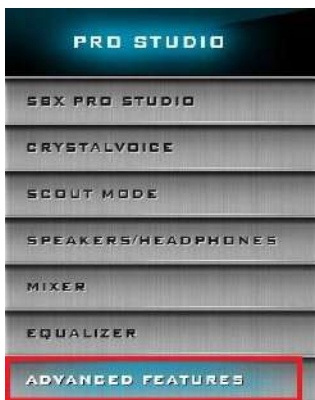

The final tab of the Sound Blaster Audio Suite is the “Advanced Features” tab. This tab has the singular option to enable or disable “Play stereo mix to digital output”.

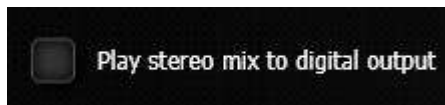

Check this box to enable output through SPDIF and speaker simultaneously. With this enabled, however, there can be significant latency between the analog and digital output.

To play Stereo Mix, make sure to enable the “Play stereo mix to digital output” first. Next, configure the Speakers as the default playback device under the Windows Control Panel for Playback Devices.

With Stereo Mix enabled, audio effects like SBX Pro Studio, EAX, Equalizer and others can be applied to the digital output. Without this feature, audio effects can only be heard through analog speakers or through headphones out.

As noted above, enabling this may create some latency between the audio source and audio playback. Here’s an example of what this means: When streaming television, movies, or other recordings, you likely will not notice any difference; the latency isn’t enough to bother your immersion or even suggest that there is latency. However, if you’re playing a game with this setting enabled, and the game requires you to press a button at exactly the moment you hear a sound, you’ll likely find that there is a small enough latency to throw you off. You’ll know the latency is caused by this setting if you disable this setting, set the Windows Default Playback device to Digital Output (SPDIF), test the game again, and find your success rate increases significantly. There is no “cure” for this latency since audio must be remixed before it can be passed to the output. If this latency causes problems, then you will need to simply set Digital Output as your default playback device.

The last section on the left menu is the profile section. This will allow you to save all settings done across all sections as a preset, and load the profile as needed.

## EVGA NU Audio

EVGA NU Audio is a second and more powerful audio output available on the EVGA Z390 DARK motherboard. Utilizing the more powerful headphone/speaker amp on the Z390 DARK, NU Audio can drive up to 600ohm headphones, as well as providing the ideal sound for every type of audio experience. The NU Audio application features a user-friendly GUI to easily and quickly adjust settings or use a preset to jump right into the action.

NU Audio is designed to work with 2.0 or 2.1 channel audio, such as headphones or speakers with or without a subwoofer. The headphones/speakers must be connected via an analog audio jack; headphones or speakers using a USB connector will not work with NU Audio. Within the NU audio GUI, you can add virtualization and EQ options by adjusting the settings. However, if you wish to use 5.1 channel audio, you must select Speakers in the Creative Sound Blaster Pro Studio, choose 5.1 from the dropdown, and use the output ports located on the I/O Panel of the motherboard (Page 16, Component 10). NU Audio will be disabled in this mode, however.

Note: While the NU Audio exists separately from the Creative Audio, some system requirements, settings, and features crossover due to shared Windows audio resources. As a result, some changes made in the Creative Sound Blaster Pro Studio will have an effect on the audio output through NU Audio.

To use NU Audio:

1. Install the EVGA Z390 DARK motherboard, including the cable to your Front Panel Audio Header (Page 14, component 25)
2. Install the Creative Sound Blaster Pro Studio Audio driver, included on the USB Flash drive with your motherboard
3. Install the “NU Audio” driver and launch the NU Audio application
4. Attach your headphones or speakers to the front panel headphone/speaker jack on your case or bay device.
5. Confirm that the Windows Playback default device is set to the Creative Audio.

Make sure that the Speakers/Headphones Configuration in the Creative Sound Blaster Pro Studio is set to Headphone, or NU Audio may be disabled. When configured properly, the Speakers/Headphones Configuration will show the slider next to Headphones, as seen below:



The EVGA NU Audio will detect whether you have speakers/headphones connected to your front panel headphone/speaker jack. If you have another audio device connected to the rear panel jacks, the rear panel device will be disabled. If the audio device is not connected, or connected to the Creative Audio ports, you will see this:



## The NU Audio Control Panel

The NU Audio control panel features a number of preset audio functions and a custom preset to allow you to manually adjust each of the NU Audio settings. Although you can use speakers with NU Audio, this guide is written assuming the user is wearing headphones.

To begin, the Control Panel has standard features, such as a volume slider, a mute button, and a settings menu.



The SETTING menu provides several options:

- i. Start With OS
  - a. Select this box to launch NU Audio when Windows starts
- ii. Start Minimized
  - a. Select this box to launch NU Audio minimized to your system tray when Windows starts
- iii. Apply previous settings on load
  - a. Select this box to launch NU Audio using the same settings set when the application was last closed
- iv. Check updates
  - a. Change this option to determine how often NU Audio will check for a new software version

When you first connect your audio device, you will see NU Audio Control Panel initially set to ORIGINAL MODE.

1. ORIGINAL Mode



The Original mode passes through a neutral, unprocessed sound that does not contain any EQ or sound adjustments. This preset is best to evaluate NU Audio directly with source audio material or contrast the sound with any of the other preset options.



## 2. SURROUND Mode



The Surround mode preset uses a combination of Reverb and Crossfeed to allow positional audio to register around your head. The Crossfeed setting will allow left and right positional audio greater freedom to cross over to the opposite side of the head, while a higher Reverb will increase the audio volume to account for the lower volume that occurs with a higher level of Crossfeed. This has the effect of creating greater immersion within whatever type of entertainment content you choose. This setting works well with a variety of content types, from gaming, movies, and certain types of music.

### 3. BASS Mode



The Bass mode is designed to give a bit more volume and reverberation to content played on this preset. The extra Reverb will increase the volume and effect of sub-bass frequencies. This setting is generally best for music, although you can increase the effect through the Custom Preset, if you wish.

#### 4. GAMING Mode



The Gaming mode preset consists of a slight bump in Reverb to provide a little more sound amplification and more noticeable positional audio to help locate sounds within a gaming environment. This preset is designed to provide an improved stereo gaming experience. For more impact, you may consider trying the Bass preset.

5. THEATER Mode



The Theater mode preset creates the ideal environment for watching movies or other visual content by expanding the virtual soundstage and increasing the volume and positional effects to compensate. By increasing the Space, the audio output has room for bigger explosions or quiet suspense, while the boost to Reverb makes sure that the effect is noticeable.

## 6. CUSTOM mode



The Custom mode preset allows you to select each of the settings and determine the correct level for your audio gear. Please note that there are many factors to consider when comparing headphones. In other words, two different pairs of headphones may have significant differences in audio quality or listening experience when using identical custom settings. For example, some headphones naturally produce a wider soundstage or higher level of Bass without any adjustment. We encourage you to test for yourself to see what sounds best with different types of content.

In Custom mode, you will notice that the names of the following settings are clickable, which will enable/disable the audio effect settings. For example, if you want to see how your audio sounds without the Reverb level you set, click the REVERB button to disable it, and the setting will become grayed out.



You can do this with each of the settings. However, Crossfeed and Cross Gain are linked and will be enabled/disabled together.

## NU Audio Custom Settings:

### a. REVERB

Reverb acts much like an amplifier for the volume. It increases the level of the audio, but it also makes a noticeable impact with positional effects by increasing or decreasing the sound made when objects collide with other objects. Use care when setting Reverb, as this will likely be the most noticeable change to your audio. Setting Reverb too high will likely create an unpleasant volume level, while insufficient Reverb will leave the audio sounding hollow and unnatural.

### b. SPACE

Space refers to the soundstage created by the headphones to both spatially identify the distance of the audio from the ear, as well as the virtual effect created to simulate the location of positional objects. This setting is essential to creating a virtual surround environment if adjusted carefully. If the Space is set too high it may be difficult to determine the location of certain sounds or certain details may be lost. Likewise, if the Space is set too low, you may find that too much detail is compressed in the same location, which means it may be difficult to separate distinct audio signatures.

### c. CROSSFEED

Crossfeed refers to how much left/right directional audio bleeds into the other ear. For example, if you hear a door slam to the right of your position, the sound will first travel to your right ear and then reach your left ear after a slight delay. This tells your brain where the sound is coming from and how far away the sound originated. Similarly, speakers recreate this effect naturally, for the most part. With headphones, however, sound is not produced in this way because each audio channel is enclosed. Crossfeed remedies this by allowing audio directed towards one channel to bleed into the opposite channel with a slight delay, thus simulating a more natural sound. Carefully adjusting Crossfeed has been known to reduce listening fatigue for some people.

For NU Audio, balancing the Crossfeed will both pass through a more natural audio experience, but it can also improve detection of positional effects from left/right audio.

d. CROSS GAIN

Cross Gain accompanies Crossfeed. Cross Gain is designed to amplify the amount of audio inserted into the opposite channel. Similar to Reverb, raising Cross Gain will increase the volume, but Cross Gain is limited to the delayed audio inserted into the opposite channel. This setting should be considered an option to fine-tune the volume of left/right audio to balance the distance between the drivers and your ears for each channel.

EVGA NU Audio brings a new audio experience to those who often rely on using their front panel audio jack. We encourage you to test out NU Audio and enjoy a more powerful listening experience.



# Using the E-LEET X Software Suite

EVGA E-LEET X is a monitoring and tuning software designed for EVGA motherboards, which is available on the driver DVD and the EVGA website at [www.evga.com/E-LEET](http://www.evga.com/E-LEET). After installation, E-LEET will launch directly to the CPU tab and show a general overview of CPU and motherboard information, including Socket information, CPU series, Core speed, core count, cache, etc.

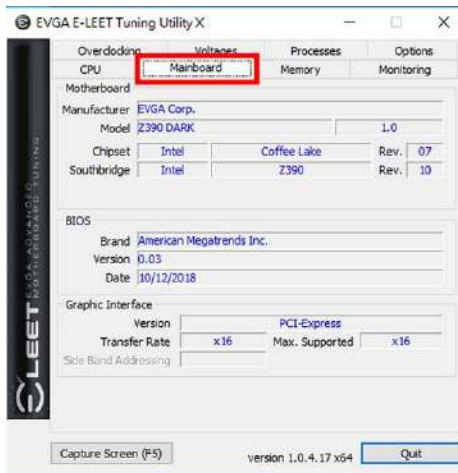

The Memory tab provides an overview of the speed and settings of your system memory. At the top, you can verify that the memory is in Dual-channel mode, the size and the NB frequency. Below, you'll find a list of timings for the RAM; not \*ALL\* of the timings are listed, but the most important and recognizable timings are listed on this tab. For the entire list, you will need to view/adjust those from within the BIOS.

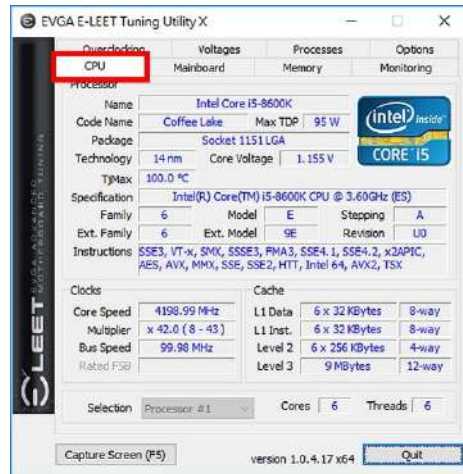

The next tab is “Mainboard,” which provides a bit more detailed information on the motherboard itself. Here, you can find the part number in the “Model” line, the CPU speed, the chipset, and even the date and revision of the BIOS.

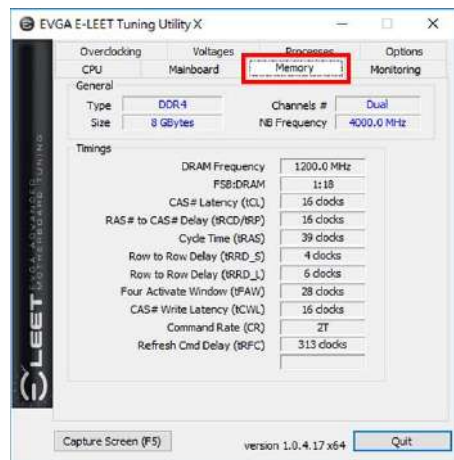

The next tab is “Monitoring,” which is an overview of temperatures and voltages in real-time. Please note that all readings on this page are pulled from motherboard sensors, and can change at any time. Temperatures and voltages are measured at fixed intervals, which can often make the readings appear to jump back and forth. Furthermore, voltages on modern motherboards are sometimes directly adaptive based on load; voltage readings \*WILL\* change based on usage, which is normal. Although E-LEET does offer functionality that will directly affect temperature and voltage readings, that functionality does not exist on this page. To adjust voltages within E-LEET, please see Page 132 for the Voltage tab information.

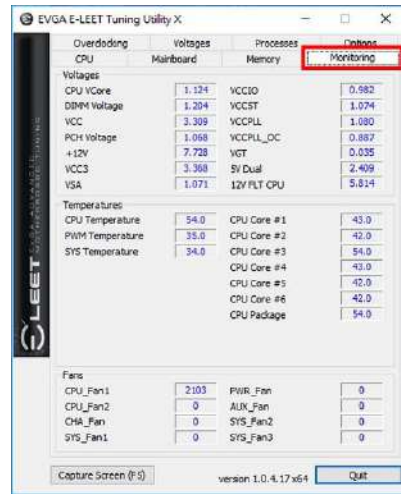

Below Voltages is Temperatures. This covers the CPU (socket), PWM, SYS, individual CPU cores, and the CPU package, which reports temperatures from the CPU Register. The bottom section is for Fans, which displays the RPM of all fans currently plugged in to the motherboard using the 4-pin fan headers.

The next tab is “Overclocking,” which covers adjustments to the BCLK, individual Cores, and the RING.

The BCLK can be adjusted by either manually moving the slider, or clicking on the arrows to the right. The BCLK can be adjusted by hundredths of a MHz. For example, the slider will show 10511, whereas the monitor will show 105.1 (rounded).

The Cores and the RING are adjusted in the same fashion, except they are adjusted by whole numbers, rather than fractions.

At the bottom is a checkbox for “Turbo Mode,” which is required to adjust clock multipliers. The Restore and Apply Settings buttons are there to either revert to factory default, or make your changed settings live.



The Options tab is for managing your E-LEET profiles. You can save overclock profiles made in the previous section, as well as selecting an option to load a profile at boot. Use care, however, when setting a profile to load on startup; if the overclock is unstable, it may prevent your system from booting to the OS.

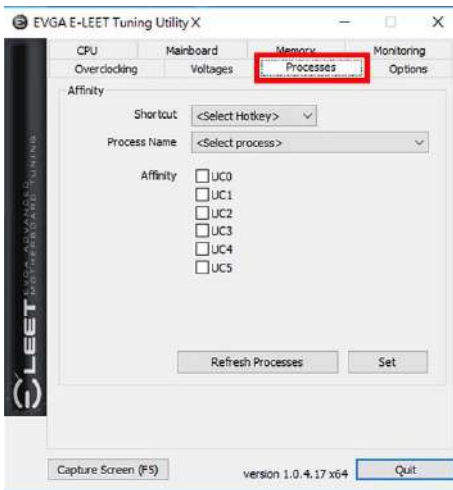
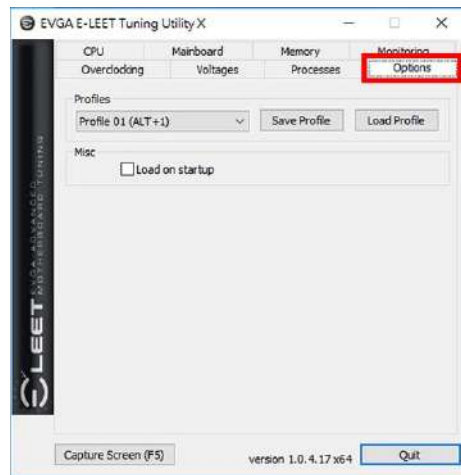

Next is the “Processes” tab, which is used to set Processor Affinity. Processor affinity is no longer used as heavily as it was in past hardware and Windows versions. However, this menu can still be used to bypass the inter-load distribution of the CPU and always set a certain CPU core or cores to run a specific process. The processes pulldown list is a snapshot only of the processes in Task Manager when E-LEET launches. Click the “Refresh Processes” button to ensure the processes list is current before making affinity setting changes, or if the process you want is not showing.

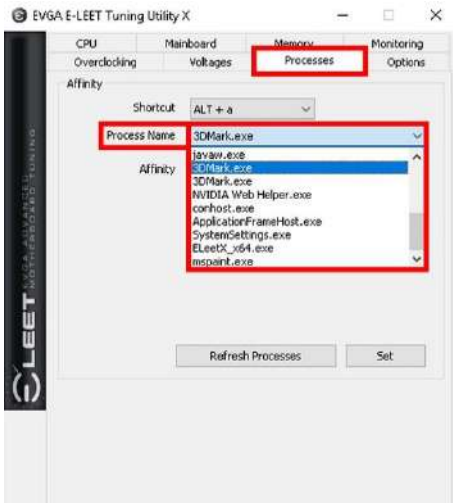

To set affinity, click on the pulldown button next to “Process Name.” Select the Process you wish to set affinity for; the file name will appear in the context menu. Finally, select which core or cores you want to assign to this process and click “Set” at the bottom.

The final section is “Voltages,” which provides a level of voltage control similar to what is available in the BIOS. Using the right image, you’ll notice that there are options for multiple voltages, and two options for your CPU Vcore: Adaptive and Override voltages.

Generally speaking, Adaptive will allow you to tailor your CPU Vcore voltage profile to keep voltage usage and heat to a minimum, while Override is more of a brute-force method of setting your CPU Vcore voltage.

Adaptive gives you both Target Voltage and Offset Voltage as an option. When adjusting Adaptive, you start by setting your target voltage, which you will discover through stress-testing your CPU. The Offset voltage is then used to fine-tune additional voltage that may be required in load or stress situations.

Override just provides a static voltage; outside of extreme benching, this setting is typically not needed or ideal for the longevity of the CPU, since the VCore is meant to fluctuate based on load. Alternatively, this can be used in the early stages of overclocking to find your Target voltage, before switching back to Adaptive.

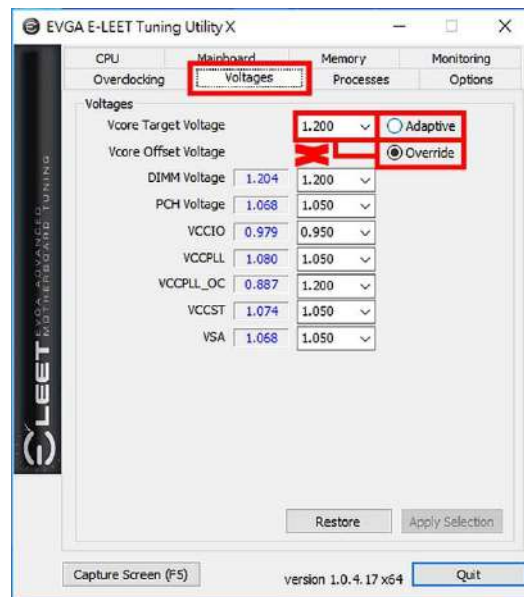
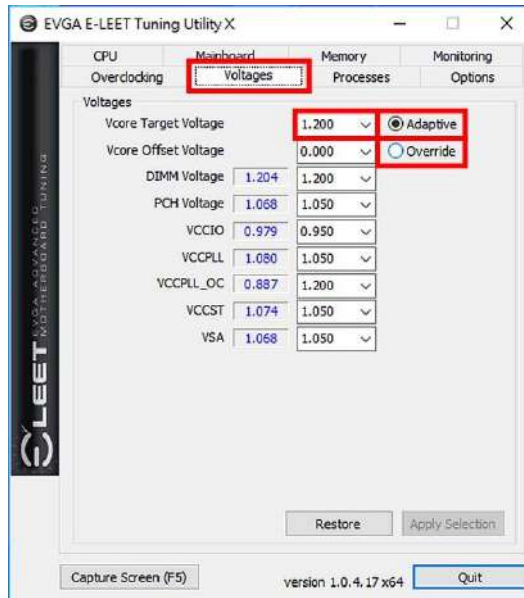

The non-CPU Vcore voltages do not utilize the Adaptive or Override voltage settings. Instead, these use a pulldown menu to select preset voltages, as shown in the image below. The voltages for these components are set by detection during POST, and E-LEET will open the pulldown to the currently detected voltage. Please be careful when adjusting voltages, as there are risks to running electronics out of spec. Although EVGA warranties overclocking, other components are manufactured by different brands (i.e. RAM and CPU), which may have different policies towards overclocking. When your changes are complete, click “Apply Selection” at the bottom, or return to defaults by clicking the “Restore” button.

Below is the voltage range list within E-LEET for Coffee Lake-S processors:

8-Core Coffee Lake-S Processors					Extreme OC Mode			
	Min.	Max.	Step	Default	Disable	Disable	Enable	
Vcore Adaptive					White	Yellow	Red	<b>Color Range</b>
Target Voltage	0.8V	1.72V	1mV	1.2V	< 1.35V	1.35 - 1.5V	> 1.5V	Combined, cannot exceed 1.72V
Offset Voltage	-500mV	+500mV	1mV	0V	< 150mV	150 - 300mV	> 300mV	
Vcore Override								
Target Voltage	0.8V	2.0V	1mV	1.0V	< 1.35V	1.35 - 1.5V	> 1.5V	
VGT Adaptive								
Target Voltage	1.2V	1.5V	1mV	1.2V	< 1.35V	1.35 - 1.5V	> 1.5V	Combined, cannot exceed 1.5V
Offset Voltage	-500mV	+500mV	1mV	0V	< 150mV	150 - 300mV	> 300mV	*Note - All Coffee Lake-S Processors have a default Vcore Override Max voltage of 2.0V. Intel's Adaptive Voltage function limits the Adaptive Max voltage, with a higher limit for 8-Core processors. Generally, voltage higher than the Adaptive Voltage function limitation should only be necessary in extreme overclocking scenarios, requiring extreme cooling.
VGT Override								
Target Voltage	1.0V	1.5V	1mV	1.0V	< 1.30V	1.30 - 1.4V	> 1.4V	CPU MSR, need reset
DIMM Voltage	1.2V	2.0V	1mV	1.2V	< 1.4V	1.4 - 1.6V	> 1.6V	
VSA	1.05V	1.8V	1mV	1.05V	< 1.2V	1.2 - 1.5V	> 1.5V	
VCCIO	0.95V	1.8V	1mV	0.95V	< 1.2V	1.2 - 1.5V	> 1.5V	
VCCPLL	1.05V	2.4V	1mV	1.05V	< 1.2V	1.2 - 1.4V	> 1.4V	
VCCPLL_OC	1.2V	3.3V	1mV	1.2V	< 1.4V	1.4 - 1.6V	> 1.6V	
Core PLL	0.9V	1.845V	1mV	0.9V	< 1.2V	1.2 - 1.4V	> 1.4V	
VCCST	1.05V	1.6V	1mV	1.05V	< 1.1V	1.1 - 1.2V	> 1.2V	
PCH 1.0	0.9V	1.7V	1mV	1.05V	< 1.1V	1.1 - 1.2V	> 1.2V	
DIMM VTT	-200mV	+200mV	1mV	0V				
DMI PLL	0.9V	2.0V	1mV	1.05V	< 1.1V	1.1 - 1.4V	> 1.4V	
USB/PCIe PLL	0.9V	2.0V	1mV	1.05V	< 1.1V	1.1 - 1.4V	> 1.4V	
BCLK PLL	0.9V	2.0V	1mV	1.05V	< 1.1V	1.1 - 1.4V	> 1.4V	
6- or 4-Core Coffee Lake-S Processors					Extreme OC Mode			
	Min.	Max.	Step	Default	Disable	Disable	Enable	
Vcore Adaptive					White	Yellow	Red	<b>Color Range</b>
Target Voltage	0.8V	1.52V	1mV	1.2V	< 1.35V	1.35 - 1.5V	> 1.5V	Combined, cannot exceed 1.52V
Offset Voltage	-500mV	+500mV	1mV	0V	< 150mV	150 - 300mV	> 300mV	
Vcore Override								
Target Voltage	0.8V	2.0V	1mV	1.0V	< 1.35V	1.35 - 1.5V	> 1.5V	

This has been the E-LEET utility overview, which should give you a solid start to understanding and using the E-LEET software suite.

# Installing Drivers and Software

**Note:** It is important to remember that before installing the drivers included in the kit, you must first load or install your operating system. The motherboard natively supports 64bit versions of Windows 10.





The kit comes with a USB flash drive that contains utilities, drivers, and additional software.

The USB flash drive that has been shipped with the EVGA Z390 DARK Motherboard contains the following software and drivers:

- Chipset Drivers
- Audio Drivers
- EVGA NU Audio Drivers
- RAID Drivers
- LAN Drivers
- ME Drivers
- EVGA E-LEET X
- User's Manual

## Windows 10 Driver Installation

1. Insert the USB flash drive included in your EVGA Z390 DARK motherboard kit into a USB port on your case or a USB port on the motherboard's rear I/O panel.
2. Double-click the "Autorun" application file.

 autorun.cdd	1/5/2018 9:17 AM	CDD File	492 KB
 autorun	1/5/2018 9:17 AM	Application	6,284 KB
 autorun	9/25/2017 3:10 PM	ICO File	9 KB
 autorun	1/5/2018 9:17 AM	Setup Information	1 KB
 autorun	1/5/2018 9:07 AM	Configuration sett...	2 KB

- The EVGA Driver Utility Screen will appear.



- EVGA strongly recommends that you install the motherboard drivers first, followed by rebooting your system. Next, install the Intel Rapid Storage drivers and reboot.
- The Driver Utility Screen also contains helpful links to give you more information about your new EVGA motherboard and additional resources to get started. The Z390 DARK manual is available through this utility and within the USB flash drive directly.
- EVGA also encourages you to register your motherboard online by either clicking on the Online Registration button in the Driver Utility, or by visiting <https://www.evga.com/register>.

---

## Warranty and Overclocking

EVGA's motherboard and graphics card components are designed for and intended for enthusiasts. To be perfectly clear, overclocking will **NOT VOID** your warranty. This means that you are free to do any type or level of overclocking you like, including traditional means, such as by using the BIOS/UEFI (for motherboards); software overclocking with EVGA utilities, such as Precision XOC or E-LEET; or even third-party software utilities. If the motherboard or card fails due to overclocking, you're covered.

Likewise, EVGA understands that enthusiasts are not always satisfied with the provided stock cooling options. Replacing heatsinks, fans, or thermal grease will **NOT VOID** your warranty. Want to install a waterblock on your new motherboard or graphics card? No problem. Planning on a long benching session with a DICE/LN2 pot? Good luck on the benching, but your warranty will still be intact after you've set new world records.

Of course, there are some limitations to our warranties. If an EVGA motherboard or graphics card sustains physical (i.e. damage to the PCB or component due to slippage with a hand tool) or liquid damage, the warranty is void. Similarly, permanent changes to components or the PCB will void your warranty, including the removal of pre-attached components soldered to the board, or the addition of components that are not removable without heat or solvents. In other words, you may use Precision XOC to raise the voltage on your graphics card while overclocking, but you may not solder on another power connector as an alternative.

If the product fails within the warranty period, you must return the product to its original configuration. This means ALL original heatsinks and fans must be reattached as they were when it was first shipped. Even if the product no longer works, it must be returned to its original state before sending it in. If you no longer have the original heatsinks you may be charged for the missing parts.

The EVGA warranty covers overclocking **ONLY** to EVGA products; EVGA is **NOT** responsible for damage caused to components manufactured by other companies. Before overclocking your system, check with the manufacturer of your other components to ensure that you will not void the warranty on those parts due to overclocking. Due to the uniqueness of every system, EVGA Customer Support cannot assist you with overclocking. For overclocking assistance, please visit our Community Forums at <http://forums.evga.com>.



# Troubleshooting

---

## Replacing a BIOS chip

Replacing a BIOS chip is typically unnecessary. In most cases, this is only needed after one of the following:

- Power failure during a BIOS update
- Failed overclock that does not recover after a hard CMOS reset
- Your motherboard was purchased just as a new line of CPUs were being released and you purchased the motherboard and one of the new CPUs at the same time (e.g. The Intel® Broadwell CPUs launched approximately nine months after the Z97 motherboards launched). Chances are, if you purchased the board and CPU together in that timeframe, retail motherboards may not have the latest BIOS with compatibility added for that new CPU, and the board may need a BIOS update to be able to POST successfully.

**FOR ANY AND ALL INSTANCES WHERE YOU THINK YOU MAY NEED A REPLACEMENT BIOS CHIP, PLEASE CALL CUSTOMER SERVICE IMMEDIATELY. DO NOT ATTEMPT TO REPLACE THE BIOS CHIP WITH ONE **\*\*NOT\*\*** SUPPLIED BY EVGA, AS EVGA CANNOT OTHERWISE GUARANTEE COMPATIBILITY. CONTACT INFORMATION, HOURS, AND LOCATIONS FOR ALL EVGA CUSTOMER SUPPORT OFFICES CAN BE FOUND HERE:**

<http://www.evga.com/about/contactus/>

The steps for replacement below assume you have already contacted EVGA Customer Support and have received a pre-flashed replacement chip directly from EVGA.

1. Locate the housing for the chip on the motherboard. It should be located about halfway down the board, near the right side. The chip will NOT be plainly visible, but under a set of gray plastic doors that keep the chip in place.
2. There is a circular mark on the bottom right of the BIOS chip, which is used for alignment (Circled in white). This chip **\*\*IS DIRECTIONAL\*\*** and inserting the replacement backwards will cause immediate failure of the motherboard and BIOS chip, including the potential for fire or smoke from the socket.
  - a. As a tip, the doors will only close correctly if the chip is mated with the socket. If the chip is not properly aligned, the door will not fully close without force, which will cause warping or damage to the door.

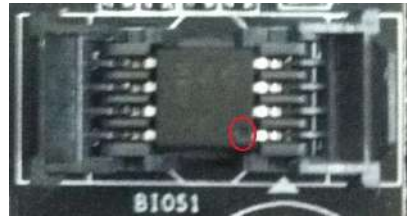
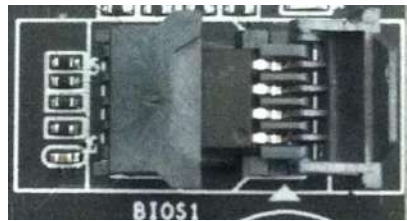
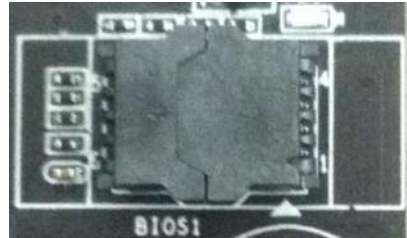

3. Remove the BIOS chip by lifting it straight up. Set it aside and insert the replacement chip. Once installed, close the left door first and the right door second, making sure both latch into place; you will feel a click when this happens. It is normal if the chip moves a little in the socket when closing the left door. Lastly, close the right door. Once both doors are closed, you've successfully replaced the BIOS chip.

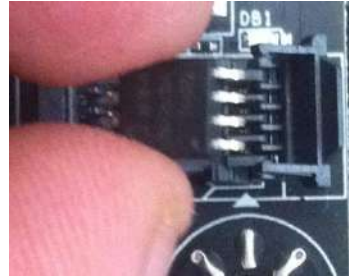

4. **NOTE: THE IMAGES BELOW ARE USED TO SHOW WHAT HAPPENS IF YOU ATTEMPT TO INSTALL THE BIOS CHIP \*\*INCORRECTLY\*\*:**

- a. If the chip is not properly aligned, the pins will seat but the top may slightly overhang the socket, making it impossible to properly seat the door.

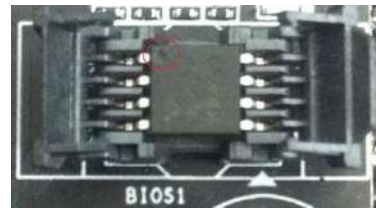

- b. When you push the left door, the chip will lift off the right side pins and the door will \*NOT\* fully close; even if you attempt to close the right door, it will not close completely. In the last picture, you can see the result of trying to close both doors with the chip installed incorrectly: neither will fully close. If forced, you will break the doors off.

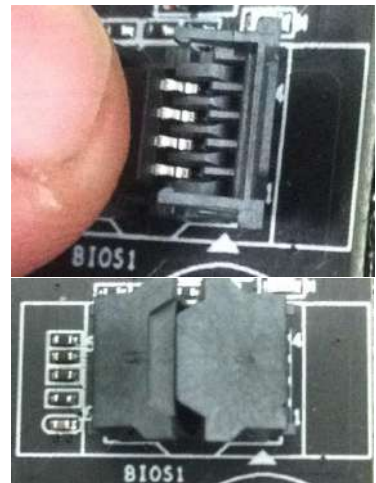

---

## Flashing the BIOS

The motherboard BIOS of your Z390 DARK will sometimes need to be updated to correct bugs, improve performance, and sometimes add features. The latest motherboard BIOS can be found at <https://www.evga.com/drivers>. Select the Motherboard tab, select the Z390 Chipset, 131-CS-E399 for the motherboard, and select BIOS to see the most recent BIOS versions.

You may update the motherboard BIOS in several ways, as we provide a method to flash via Windows, update via USB from within the BIOS, or update using the force method described below in the section, “Flashing the BIOS Without a CPU”.

For ease of use, you may use the included USB flash drive provided with your motherboard kit. If you use a different USB flash drive, please make sure to properly format the flash drive to FAT32 before trying to flash the BIOS.

### A. To flash via Windows:

- a. Download the latest motherboard BIOS from the EVGA Download page, linked above.
- b. Unzip the downloaded file to your desktop.
- c. Make sure to close all open software and applications.
- d. Open the folder and double-click the “Update.bat” file.
- e. The flash utility will begin. If prompted, type “Y” to begin the flash.
- f. **DO NOT TURN OFF THE MOTHERBOARD UNTIL THE FLASH IS COMPLETE.**
- g. When complete, the motherboard will automatically shut down. Power on the motherboard to go into the motherboard BIOS.
- h. When you see the Z390 DARK splash screen, quickly tap the Delete key to enter the BIOS. Confirm that the BIOS has been updated to the latest version by checking the BIOS version (located in the bottom-right of the screen) with the BIOS version you downloaded.

**Note:** If the flash box immediately closes after running Update.bat, you may need to run Update.bat from a command prompt with administrator privileges, or right-click Update.bat and select “Run as administrator”.

### B. To flash from within the Z390 DARK BIOS:

- a. Download the latest motherboard BIOS, and unzip the file to your desktop.
- b. Drag the unzipped folder into your USB flash drive.

- c. Reboot the motherboard. When the Z390 DARK splash screen appears, tap the Delete key to enter the BIOS.
- d. Once inside the BIOS, navigate to the EXTRAS tab, and select BIOS Update:
- e. Navigate to the folder containing the BIOS files. Select the correct .bin file from the dropdown list.
- f. After selecting the file, confirm that you wish to update the motherboard BIOS.
- g. After confirming the download, you'll see an indication that the BIOS is updating.



DO NOT POWER OFF THE MOTHERBOARD WHILE THE BIOS IS UPDATING.

- h. Once the update is finished, the motherboard will power off. Power on the motherboard and enter the BIOS, using the method described above. It is normal to see an error message after updating your BIOS such as the one below:
- i. Confirm that the BIOS has been updated to the latest version by checking the BIOS version (located in the bottom-right of the screen) with the BIOS version you downloaded.



**Note:** Your USB flash drive must be formatted as FAT32, or this method of flashing the BIOS will not work. The USB flash drive included with your motherboard is already properly formatted to FAT32. If you plan to use your own USB flash drive, however, please make sure the file system is correct before attempting this method.

C. To flash from power on state:

A third method of flashing the BIOS can be done without going into the BIOS or from within Windows. The steps for flashing directly from power on are located below, in the “Flashing the BIOS Without a CPU” section. These steps will explain how to prepare the USB flash drive included with your Z390 DARK motherboard to update with a newer BIOS using the method below.

- a. Plug in the USB flash drive included with your Z390 DARK motherboard, and boot into Windows.
- b. Navigate to the USB flash drive so you can view the installed folders. In the root of the flash drive, you should notice a file named “EVGAE399” or “EVGAE399.bin”. We highly recommend that you make a backup of this file, in case you discover an issue with the new BIOS or are unable to boot after flashing the new BIOS.



- c. Download the latest BIOS for the Z390 DARK from <https://www.evga.com/drivers>, and unzip the file to your desktop.
- d. Inside the folder will also be a .bin file with the name of the new BIOS. Right-click the .bin file and select “Rename”. Change the name to “EVGAE399.bin”.
- e. Replace the existing EVGAE399.bin file in the EVGA USB flash drive with the new BIOS that you downloaded and renamed.
- f. At this point, you are ready to begin the BIOS update. Follow the steps in the “Flashing the BIOS Without a CPU” in the section below.

## Flashing the BIOS Without a CPU



If your motherboard cannot boot, or you are unable to see picture on your display, there can be a number of potential causes preventing your motherboard from completing a successful boot. Some of these are listed and explained below.

If other troubleshooting does not resolve your issue, or you've purchased this motherboard with a BIOS version prior to official support for your compatible Intel® CPU, you may need to flash the BIOS.

**Note:** Before you begin, make sure that your USB flash drive is formatted as FAT32, or this method of flashing the BIOS will not work, as noted above.

If you plan to use the included USB flash drive with the latest BIOS version from the EVGA Website, please make sure to first follow the steps listed above for the "To flash from power on state" section to prepare the flash drive. Once the latest BIOS is placed in the root folder and renamed EVGAE399.bin, you are ready to proceed with the BIOS update.

In order to flash the BIOS without picture, you must follow these steps:

1. Turn off your Z390 DARK motherboard, if on, and turn your power supply off by flipping the switch to the "Off" position.
2. Plug in the included USB flash drive to the USB 2.0 to SPI header, as noted in the component legend on Page 14, component 34, or refer to this image: 
3. Make sure the 24pin power connector from your power supply is plugged in to the motherboard.
4. When ready, flip your power supply switch to the "On" position and hold down the reset key. 
5. Continue holding down the reset key, as the POST LED counts down from 4. 
6. When the flash begins, release the reset key. The POST LED will cycle in a clockwise manner during the flash process.

**DO NOT TURN OFF THE MOTHERBOARD. IF THE MOTHERBOARD IS TURNED OFF PRIOR TO COMPLETING THE FLASH PROCESS, THE BIOS MAY BECOME IRREVERSIBLY DAMAGED.**

The flash process may take up to 3 minutes. When finished, the motherboard will automatically reboot. If you have not installed a CPU and at least one 8-pin CPU power connector, the POST LED will stop at C. If this occurs, turn off the motherboard and power supply and install any remaining hardware components before attempting to boot again.

---

## SSD / HDD is not detected

It is important to note that, as with *\*ALL\** storage devices, if there is a connectivity issue, make sure it is enabled in BIOS. Likewise, if there is a device that shares bandwidth with your SSD or HDD (Page 27), make sure that the desired device is enabled in BIOS, or all other troubleshooting that comes after this section is moot.

If you've physically installed a drive that is not detected in Windows, by Windows setup, or within BIOS, please try the following steps. Component troubleshooting is primarily accomplished through process of elimination testing to deduce a faulty component or a bad connection.

### **Device is not receiving power:**

For devices with external power, such as SATA or U.2, make sure power is connected to the drive, and that the other side of the cable is attached to the correct port on your PSU. If you are using a mechanical drive (either a platter HDD or an optical drive) you should hear the motor spin up when you first power on the system. Similarly, if you put your hand on the device you should feel the drive spin up, warmth from the motor, and a light on the front from an optical drive. If you see, hear, and feel this, then the device is receiving power, and you may skip to the next section. If you do not see, hear, or feel this, first try the cable on a device that you know works; if the cable works, then the issue is the device in question.

However, if you replace the device and the issue persists, then it is either the PSU, one of its modular cables or the port the cable is plugged into. If you are using a modular cable, try a different cable in the same PSU port, and also test on a different port to isolate the source of the problem. In many cases, the PSU manufacturer may be able to replace the cable if it is bad.

### **Device has power, but does not show up in the BIOS:**

If the device is getting power, then we should expect to see the drive in BIOS, unless you are using a third party controller, such as Marvel or ASMedia; for devices on third-



party controllers, go to Page 84 to see if the device(s) show up in Windows Disk Management. If the drive does not show in the SATA Configuration screen in BIOS, make sure the SATA cable is firmly seated on both the drive side and the motherboard. As noted above, if you are using a device on a connector that shares its bandwidth, you will need to check and/or change the BIOS setting related to your device.

If you've already done this, test a different device using the same cable and SATA port to see if the issue persists. If the issue is not resolved, test a different SATA cable, or a different SATA port. Always be sure to test each step separately, otherwise, if several aspects are changed and drives are now detected, then you will not know what change actually fixed it. If other devices work on the ports and with the same cables, then the issue is the device in question. If testing shows that either one or more of the ports are bad with a different device, then the motherboard is likely the issue. If one or more of the cables test bad with a different device, then replacing the cable(s) should resolve the issue.

M.2 devices have a bit less to test due to their connection that provides data and power through a single socket. M.2 devices are installed at an angle, gently pushed down flush with the motherboard, and then fastened into place. M.2 drives only fit one way, and cannot fit upside-down; however, you can have a bad connection if the card is not pushed all the way into the slot before bolting it down. Please refer to Page 34 for M.2 hardware installation, and Page 52 for setup.

**Device has power, is seen in BIOS, but cannot be found in Windows:**

Lastly, if the device was just added, other troubleshooting in this section has been done, the device has power and shows up in the BIOS, but is not seen in Windows, then it may be that the drive needs to be initialized, partitioned, and formatted in Windows. See Page 84 for instructions.

---

## System does not POST, and POST code indicator reads “C”

When the system powers on, the POST code indicator should cycle through several different codes before booting. However, if the boot process does not complete, you should look at the LED indicator, as it will give you diagnostic information. When a POST code indicator cycles through codes and stops at a specific code, this is an indication that initialization of a specific component or process on the board failed. If you power on the board and it goes directly to “C,” and nothing else, that is an indication of a CPU-related issue. If the board cannot detect the CPU in the socket, the POST code display will display a “C”, as well. It is not likely a faulty CPU, although it is possible; instead, it is most likely a CPU power issue. To the right of the CPU socket, there are two 8-pin power connectors (outlined in **RED** in the image to the right). These connectors are the main power for the CPU, and without power from the PSU the system cannot fully power on and initialize. Depending on your motherboard, you may have one or two of these connectors; at least one must be plugged in. Both of these connectors are equivalent.

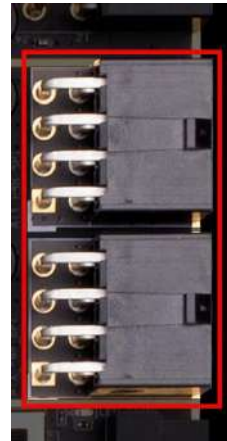

Make sure the plug is fully-seated and also make sure that the tab on the socket and the release on the power connector are on the same side (see the box in **RED** on the second picture for the tab on the EPS connector). If the connectors do not line up, then you have plugged in a PCIe 8-pin into the EPS connector, which may cause irreparable damage to the motherboard or the CPU. For the Z399 DARK, attempting to plug in an 8-pin PCIe plug will likely damage the motherboard's PCB due to the right-angle connectors.



If the PSU is modular, make sure the cable is fully-seated on the PSU side as well. Also, only use cables from your PSU manufacturer for your specific PSU, because using a cable designed for a different PSU may have catastrophic effects. Finally, ensure that the cable on the PSU side is plugged into the connector for the CPU, typically labelled “CPU” or “EPS,” but consult your power supply manual for the correct plug.

---

## System does not POST, and POST code indicator reads “55”

A POST code error reading “55” indicates a memory issue. Verify that memory is installed, and that it is properly seated. Make sure that the memory is on the official support list at [www.evga.com/support/motherboard](http://www.evga.com/support/motherboard) and click on “EVGA Z390 DARK.” If the memory is not on the list, it may still work because EVGA is unable to test every memory kit released. However, this motherboard will not support modules over 16GB or ECC/Registered RAM.

If your memory should work on this motherboard, the next step is to bring it down to one stick of memory in “DIMM slot 2” and retest. If this is your first boot with the motherboard and the board will not POST, your next step is to press the “Reset CMOS” button. The system will power on when the Reset CMOS button is pressed, which is normal. This should allow the system to boot up. When you see the EVGA Z390 DARK screen, press “Del” to enter BIOS, set the XMP (instructions are covered in first boot section on Page 50), press F10 to save and exit, which will reboot the system. If the system reboots successfully, you can power down and install the rest of the memory to retest.

---

## System does not POST, and POST code indicator reads “d7”

If the motherboard cannot detect a Keyboard, the system will fail to POST with a “d7” POST code. When this happens, some video card / monitor setups will display a message on screen about a Keyboard error, while others will just remain blank. If this happens, power down the system and reseat the USB connector. Make sure the Keyboard is NOT in the USB 3.1 Type-A connector, as this port requires drivers to initialize and fully function. However, this error can sometimes happen with older wireless keyboards, as well. If this is the case, we recommended that you plug in a regular USB keyboard, reboot, enter BIOS, and go to Advanced – USB Configuration. Make sure “Legacy USB Support” is set to “enabled,” then press F10 to save an exit. Your keyboard should now work, and the board should POST past “d7.”

---

## Have a question not covered above, or want some online resources?

If you have any issues or questions, you can find a lot of valuable help and information on our website, including contact information for our US Technical Support/Customer Service.

- You may find all of the motherboard drivers at <http://www.evga.com/support/download/>. Select the “Motherboard” tab, then select “Intel Z390” from the Family tab, then “131-CS-E399” from the part number pulldown. Next, select either “All” or the specific component that requires a driver, then select your operating system and click “Submit”
- You may find the list of officially supported CPUs and System RAM for your motherboard, including the minimum required BIOS revision for compatibility, at: <http://www.evga.com/support/motherboard/>. BIOS updates are cumulative, so they will always support products from the previous version, except when specified otherwise.
- For our Frequently Asked Questions (FAQ) database, go to: <http://www.evga.com/support/knowledgebase/>
- To visit our Community Forums, go to: <http://forums.evga.com/>
- For our Community Forums section dedicated to Z390 motherboards, go to: <https://forums.evga.com/EVGA-Z390Z370H370B360-Series-f106.aspx>
- Just finished building or upgrading your system and want to show it off? Make a ModsRigs Profile here: <http://www.modsrigs.com/> and create a page dedicated entirely to YOUR system!
- Still building your rig? Make a build log here: <http://forums.evga.com/EVGA-MODS-RIGS-f33.aspx>
- Want to join the online EVGA Gaming Community? Sign up and play with like-minded gamers here: <http://www.evga.com/TEAMEVGA/>

---

## Multifunction LED indicator

EVGA Z390 DARK board is equipped with a versatile display to allow real-time monitoring of system status during and after the BIOS POST process. The operating mode can be configured in the BIOS Setup in the Advanced menu, and then H/W Monitor Configuration. The Debut Port Display setting selects the OS display mode. There are multiple modes available:

- ❑ BIOS Only – displays only BIOS POST completion.
- ❑ CPU Temperature – displays external CPU die temperature sensor readout in real-time. Use this mode to read negative temperatures.
- ❑ PWM Temperature – displays VRM temperature sensor readout in real-time after BIOS POST completion.
- ❑ SYS Temperature – displays motherboard bay temperature sensors.
- ❑ CPU Vcore – displays CPU VCORE after BIOS POST completion.
- ❑ MEM Voltage – displays DIMM voltage after BIOS POST completion.
- ❑ VCCIO Voltage – displays I/O voltage after BIOS POST completion.
- ❑ VSA – displays System Agent CPU voltage after BIOS POST completion.
- ❑ VCCST – displays Standby CPU voltage after BIOS POST completion.
- ❑ VCCPLL – displays PLL CPU voltage after BIOS POST completion.
- ❑ VCCPLL\_OC – displays PLL OC CPU voltage after BIOS POST completion.
- ❑ VTT – displays DIMM termination voltage after BIOS POST completion.
- ❑ Disabled - completely deactivates 80Port LED display

The Debug Port Display menu the BIOS Setup allows you to pick specific sensors to be displayed on the 80Port.

These temperatures and voltages can also be seen in the BIOS setup window in real-time, for a quick overview.

The recommended settings to display during overclocking are “CPU Vcore” and “CPU Temperature.”

36°C | EVGA | 0.953 V

FREQUENCY: 2400 MHz | TOTAL SIZE: 4 GB | VOLTAGE: 1.204 V

3.20 CPU CLOCK [32 x 100.0] CPU RATIO x BCLK

MEMORY | DC | MEMORY | **ADVANCED** | BOOT | SAVE & EXIT

**EXTRAS**

- CPU Die Temperature
- CPU Temperature
- PWM Temperature
- SYS Temperature
- ATX 6P
- M.2 KEY-M(1)
- M.2 KEY-M(2)
- VDIMM VRM
- PE2

Debug Port Display

CPU_FAN1 Speed	N/A	SMART	⊕ ⊖
Smart Fan Settings			
CPU_FAN2 Speed	1126 RPM	SMART	⊕ ⊖
Smart Fan Settings			
CHA_FAN Speed	N/A	SMART	⊕ ⊖
Smart Fan Settings			
SYS_FAN1 Speed	N/A	SMART	⊕ ⊖
Smart Fan Settings			
PWR_FAN Speed	N/A	SMART	⊕ ⊖
Smart Fan Settings			
AUX_FAN Speed	N/A	SMART	⊕ ⊖

**BIOS Only**

- CPU Temperature
- PWM Temperature
- SYS Temperature
- CPU VCore
- MEM Voltage
- VCCIO Voltage
- VSA
- VCCST
- VCCPLL
- VCCPLL\_OC
- VTT
- Disabled

VCCIO Voltage

Select mode of 80Port Debug display.  
 BIOS only - show POST code.  
 Temperature - monitors device temperature.  
 Voltage - monitors voltage.  
 Disabled - turn off display after POST.

F1 : General Help  
 F5 : Optimized Defaults  
 F7/B : Save/Load Profile  
 F9 : Last Saved Settings  
 F10 : Save & Exit Setup  
 ESC/Right Click : Exit

F12 BIOS v0.03

36°C | EVGA | 0.953 V

FREQUENCY: 2400 MHz | TOTAL SIZE: 4 GB | VOLTAGE: 1.204 V

3.20 CPU CLOCK [32 x 100.0] CPU RATIO x BCLK

MEMORY | DC | MEMORY | **ADVANCED** | BOOT | SAVE & EXIT

**EXTRAS**

- CPU Die Temperature
- CPU Temperature
- PWM Temperature
- SYS Temperature
- ATX 6P
- M.2 KEY-M(1)
- M.2 KEY-M(2)
- VDIMM VRM
- PE2

Debug Port Display

CPU_FAN1 Speed	N/A	SMART	⊕ ⊖
Smart Fan Settings			
CPU_FAN2 Speed	1272 RPM	SMART	⊕ ⊖
Smart Fan Settings			
CHA_FAN Speed	N/A	SMART	⊕ ⊖
Smart Fan Settings			
SYS_FAN1 Speed	N/A	SMART	⊕ ⊖
Smart Fan Settings			
PWR_FAN Speed	N/A	SMART	⊕ ⊖
Smart Fan Settings			
AUX_FAN Speed	N/A	SMART	⊕ ⊖

**SYS Temperature**

- CPU VCore
- MEM Voltage
- VCCIO Voltage
- VSA
- VCCST
- VCCPLL
- VCCPLL\_OC
- VTT
- Disabled

VCCIO Voltage

Select mode of 80Port Debug display.  
 BIOS only - show POST code.  
 Temperature - monitors device temperature.  
 Voltage - monitors voltage.  
 Disabled - turn off display after POST.

F1 : General Help  
 F5 : Optimized Defaults  
 F7/B : Save/Load Profile  
 F9 : Last Saved Settings  
 F10 : Save & Exit Setup  
 ESC/Right Click : Exit

F12 BIOS v0.03

## POST Beep codes

POST beeps are used in conjunction with the POST Code indicator to help determine the root cause when your system fails to boot. However, modern UEFI/BIOS motherboards also use the speaker to convey helpful information, such as USB device detection. As a result, users may become confused about the number of beeps emitted, making the POST code beep - while still helpful - not as useful as it once was.

Beep Codes	
# of Beeps	Description
1	Invalid Password
4	Some of the Architectural Protocols are not Available
5	No Console Output Device detected
5	No Console Input Device detected
6	Flash Update Failed
7	Reset Protocol is not available
8	Platform PCI resource requirements cannot be met

Many motherboards will beep 1-2 times per USB device plugged in at boot; some will beep more based on functions of the device. These detection beeps may occur at the same time as the system's POST beeps, sometimes making it a challenge to separate the POST beeps from the USB initialization. Since the POST code indicator now fills most of the role previously held by audible beeps, there are far fewer POST beeps to help debug problems, compared to previous motherboard generations.

**1 Beep:** This relates to BIOS boot passwords. The BIOS will beep, indicating that a password is required to boot. If you incorrectly enter your BIOS password when prompted by the BIOS, you will receive one beep.

**4 Beeps:** This is an error relating to some small recovery errors, which can occur when coming out of sleep/hibernate.

**5 Beeps:** This error is stating it cannot detect a keyboard. This can also indicate a video card is not detected.

**6 Beeps:** This relates to either a failed BIOS update, or a failed Intel® ME Firmware update.

**7 Beeps:** This relates to a failed CPU INIT request. EFI/UEFI Reset protocol is used when a processor INIT call is used and was not successful. This returns either an "EFI\_UNSUPPORTED" error if the INIT type is not supported or an "EFI\_Device\_Error" if the error occurs while generating the INIT; either will result in seven (7) POST beeps.

**8 Beeps:** Error given when an incompatible PCI Express device is installed and cannot initialize properly.

---

## POST Port Debug LED

Provides two-digit diagnostic POST codes that shows system boot status and can also show why the system may be failing to boot. The LED is extremely useful during troubleshooting situations.

This Debug LED will display a series of hexadecimal (0-F) codes during the POST and will display current CPU socket temperatures after the system has fully booted into the Operating System. See the “POST CODE” section below for more detailed descriptions of specific POST Codes.

Debug LED with CPU  
Temperature Monitor

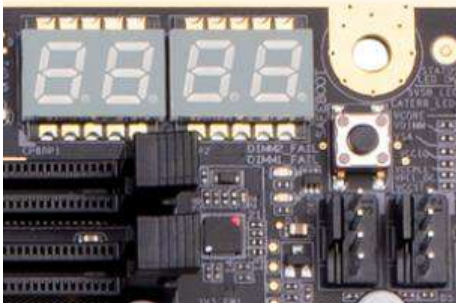



# POST Codes

This section provides the AMI POST Codes for the EVGA Z390 DARK Motherboard during system boot up. The POST Codes are displayed on the Debug LED readout located directly on the motherboard. See Page 14 and 15, component 21 of the Component Legend for physical location.

This Debug LED will switch to display the user's 80Port Configuration settings after POST (see Page 149). Please note that if you see the Debug LED constantly switching numbers after entering Windows, the Debug LED is showing temperature or voltage information, and is NOT reporting errors.

Debug LED with CPU Temperature Monitor

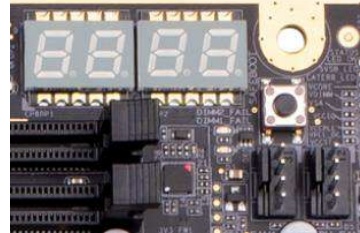

## AMI POST Codes

1	Power on. Reset type detection (soft/hard).
2	AP initialization before microcode loading
3	North Bridge initialization before microcode loading
4	South Bridge initialization before microcode loading
5	OEM initialization before microcode loading
6	Microcode loading
7	AP initialization after microcode loading
8	North Bridge initialization after microcode loading
9	South Bridge initialization after microcode loading
0A	OEM initialization after microcode loading
0B	Cache initialization
0C-0D	Reserved for future AMI SEC error codes
0E	Microcode not found

0F	Microcode not loaded
10	PEI Core is started
11-14	Pre-memory CPU initialization is started
15-18	Pre-memory North Bridge initialization is started
19-1C	Pre-memory South Bridge initialization is started
1D-2A	OEM pre-memory initialization codes
2B	Memory initialization. Serial Presence Detect (SPD) data reading
2C	Memory initialization. Memory presence detection
2D	Memory initialization. Programming memory timing information
2E	Memory initialization. Configuring memory
2F	Memory initialization (other).
30	Reserved for ASL (see ASL Status Codes section below)
31	Memory Installed
32	CPU post-memory initialization is started
33	CPU post-memory initialization. Cache initialization
34	CPU post-memory initialization. Application Processor(s) (AP) initialization
35	CPU post-memory initialization. Boot Strap Processor (BSP) selection
36	CPU post-memory initialization. System Management Mode (SMM) initialization
37-3A	Post-Memory North Bridge initialization is started
3B-3E	Post-Memory South Bridge initialization is started
3F-4E	OEM post memory initialization codes
4F	DXE IPL is started
50	Memory initialization error. Invalid memory type or incompatible memory speed
51	Memory initialization error. SPD reading has failed
52	Memory initialization error. Invalid memory size or memory modules do not match.
53	Memory initialization error. No usable memory detected
54	Unspecified memory initialization error.
55	Memory not installed
56	Invalid CPU type or Speed
57	CPU mismatch
58	CPU self-test failed or possible CPU cache error
59	CPU micro-code is not found or micro-code update is failed
5A	Internal CPU error

5B	reset PPI is not available
5C-5F	Reserved for future AML error codes
E0	S3 Resume is started (S3 Resume PPI is called by the DXE IPL)
E1	S3 Boot Script execution
E2	Video repost
E3	OS S3 wake vector call
E4-E7	Reserved for future AML progress codes
E8-EB	S3 Resume Failed
EC-EF	Reserved for future AML error codes
F0	Recovery condition triggered by firmware (Auto recovery)
F1	Recovery condition triggered by user (Forced recovery)
F2	Recovery process started
F3	Recovery firmware image is found
F4	Recovery firmware image is loaded
F5-F7	Reserved for future AML progress codes
F8	Recovery PPI is not available
F9	Recovery capsule is not found
FA	Invalid recovery capsule
FB–FF	Reserved for future AML error codes
60	DXE Core is started
61	NVRAM initialization
62	Installation of the South Bridge Runtime Services
63-67	CPU DXE initialization is started
68	PCI host bridge initialization
69	North Bridge DXE initialization is started
6A	North Bridge DXE SMM initialization is started
6B-6F	North Bridge DXE initialization (North Bridge module specific)
70	South Bridge DXE initialization is started
71	South Bridge DXE SMM initialization is started
72	South Bridge devices initialization
73-77	South Bridge DXE Initialization (South Bridge module specific)
78	ACPI module initialization

79	CSM initialization
7A–7F	Reserved for future AMI DXE codes
80–8F	OEM DXE initialization codes
90	Boot Device Selection (BDS) phase is started
91	Driver connecting is started
92	PCI Bus initialization is started
93	PCI Bus Hot Plug Controller Initialization
94	PCI Bus Enumeration
95	PCI Bus Request Resources
96	PCI Bus Assign Resources
97	Console Output devices connect
98	Console input devices connect
99	Super IO Initialization
9A	USB initialization is started
9B	USB Reset
9C	USB Detect
9D	USB Enable
9E–9F	Reserved for future AMI codes
A0	IDE initialization is started
A1	IDE Reset
A2	IDE Detect
A3	IDE Enable
A4	SCSI initialization is started
A5	SCSI Reset
A6	SCSI Detect
A7	SCSI Enable
A8	Setup Verifying Password
A9	Start of Setup
AA	Reserved for ASL (see ASL Status Codes section below)
AB	Setup Input Wait
AC	Reserved for ASL (see ASL Status Codes section below)
AD	Ready To Boot event

AE	Legacy Boot event
AF	Exit Boot Services event
B0	CPU Memory controller configuration
B1	Runtime Set Virtual Address MAP End
B2	iMC init
B3	Memory training
B4	Memory training
B5	Memory training / timing training
B6	Memory training
B7	Memory training
B8-BF	Memory training / DRAM final configuration
C0-CF	OEM BDS initialization codes
D0	CPU initialization error
D1	North Bridge initialization error
D2	South Bridge initialization error
D3	Some of the Architectural Protocols are not available
D4	PCI resource allocation error. Out of Resources
D5	No Space for Legacy Option ROM
D6	No Console Output Devices are found
D7	No Console Input Devices are found
D8	Invalid password
D9	Error loading Boot Option (Load Image returned error)
DA	Boot Option is failed (Start Image returned error)

## EVGA Glossary of Terms

AC – Alternating Current

ACPI - Advanced Configuration and Power Interface

AHCI – Advanced Host Controller Interface

APIC - Advanced Programmable Interrupt Controller

BCLK – Base Clock (or operating frequency of base system bus)

BIOS - Basic Input Output System

CMOS - Complementary Metal-Oxide Semiconductor

CPU – Central Processing Unit

DC – Direct Current

DDR - Double Data Rate

DIMM - Dual In-line Memory Module

DMI – Direct Memory Interface

DP – Display Port

DRAM - Dynamic random access memory

DVI – Digital Video Interface

E-LEET/E-LEET X – EVGA motherboard monitoring and tuning software

FIVR – Fully Integrated Voltage Regulator

GHz – Gigahertz

GPIO (Thunderbolt) – General Purpose Input/Output

GPU – Graphics Processing Unit

GUI – Graphical User Interface

HDD - Hard Disk Drive

HDMI - High-Definition Multimedia Interface

HDR – High Dynamic Range (Lighting)

HPET - High Precision Event Timer

HT – Hyper-Threading

HSF - Heat Sink Fan

I/O - Input/Output

IEEE - Institute of Electrical and Electronics Engineers

IGP - Integrated Graphics Processors

IMC – Integrated memory controller

IOH – Input/Output Hub

IRQ - Interrupt Request

JBOD - Just a Bunch of Disks

JEDEC - Joint Electron Device Engineering Council

LAN - Local Area Network

LCD - Liquid Crystal Display

LGA – Land Grid Array

LN2 – Liquid Nitrogen Cooling

MAC - Media Access Control

M.2 – **A card bus based standard commonly used for VERY fast SSD's, and WiFi.**

MCP - Media and Communications Processor

Intel® ME – Intel® Management Engine

MHz – Megahertz

MMIO – Memory Mapped I/O

NB - Northbridge

NCQ - Native Command Queuing

NIC - Network Interface Card

NTFS - New Technology File System

NVMe – Non-Volatile Memory Express

OEM - Original Equipment Manufacturer

PATA - Parallel Advanced Technology Attachment

PCB - Printed Circuit Board

PCH – Platform Controller Hub

PCI - Peripheral Component Interconnect

PCIe - Peripheral Component Interconnect Express

PLL – Phase Locked Loop

POST – Power on Self-Test

PWM – Pulse Width Modulation

QDR - Quad Data Rate

QOS – Quality of Service

QPI – Quick Path Interconnect

RAID - Redundant Array of Inexpensive Disks

RAM – Random Access Memory

ROM – Read Only Memory

RGB - Red Green Blue

SATA - Serial Advanced Technology Attachment

SAS – Serial Attached SCSI

SB - Southbridge

SCSI - Small Computer System Interface

SFR – Split Frame Rendering

SLI - Scalable Link Interface

SPD - Serial Presence Detect

S/PDIF - Sony/Philips Digital Interconnect Format

SPP - System Platform Processors

SSD – Solid State Drive

TCP/IP - Transmission Control Protocol/Internet Protocol

Thunderbolt – High-speed hot-swappable interface (similar function to USB)

U.2 – High-Speed storage interface also referred to as SFF-8639

UDP – User Datagram Protocol

UEFI – Unified Extensible Firmware Interface

USB - Universal Serial Bus

VDroop - Voltage Droop

VGA - Video Graphics Array

VREG – Voltage Regulator



# Compliance Information

## FCC Compliance Information

This device complies with FCC Rules Part 15. Operation is subject to the following two conditions: (1) This device may not cause harmful interference, and (2) this device must accept any interference received, including interference that may cause undesired operation. This equipment has been tested and found to comply with the limits for a Class B digital device, pursuant to Part 15 of the FCC Rules. These limits are designed to provide reasonable protection against harmful interference in a residential installation. This equipment generates, uses and can radiate radio frequency energy and, if not installed and used in accordance with the manufacturer's instructions, may cause harmful interference to radio communications. However, there is no guarantee that interference will not occur in a particular installation. If this equipment does cause harmful interference to radio or television reception, which can be determined by turning the equipment off and on, the user is encouraged to try to correct the interference by one or more of the following measures: (1) Increase the separation between the equipment and signal source, or (2) connect the equipment to an outlet on a circuit different from that to which the signal source is connected. Consult the dealer or an experienced computer technician for help. The use of shielded cables for connection of peripheral devices to the PC systems is required to ensure compliance with FCC regulations. Changes or modifications to this unit not expressly approved by the party responsible for compliance could void the user's authority to operate the equipment.

## CE Compliance Information

Generic Radiation Interference Standard for Information Technology Equipment. (EN 55022: 2006, Class B), (EN 61000-3-2: 2006), (EN 61000-3-3: 1995 + A1: 2001 + A2: 2005). Warning: This is a Class B product. In a domestic environment this product may cause radio interference in which case the user may be required to take adequate measure. Generic Immunity Standard for Information Technology Equipment. (EN 55024: 1998 + A1: 2001 + A2: 2003).

## Trademark & Copyright Information

2001-2018 EVGA Corp. EVGA, the EVGA logo and combinations thereof are trademarks of EVGA Corp. All brand names, company names, service marks, logos, and trademarks of the company, or its affiliates or licensors are trademarks or registered trademarks of the company or its subsidiaries, affiliates or licensors in the US and other countries. Other company, products and service names may be trademarks or service marks of others. EVGA reserves the right to terminate this license if there is a violation of its terms or default by the Original Purchaser. Upon termination, for any reason, all copies of Software and materials must be immediately returned to EVGA and the Original Purchaser shall be liable to EVGA.com CORP for any and all damages suffered as a result of the violation or default.

## Legal Information

All material including but not limited to, text, data, design specifications, diagnostics, graphics, logos, reference boards, files, images, drawings, and software including this document and the software itself (together and separately) is owned, controlled by, licensed to, or used with permission by EVGA Corporation and is protected by copyright, trademark, and other Intellectual property rights. All is being provided "as is", EVGA Corporation makes no warranties, whether express or implied, statutory or otherwise with respect to the materials and expressly disclaims all implied warranties of non-infringement, merchantability, and fitness for a particular purpose. In no event shall the liability of EVGA Corporation for claims arising from the use of the materials by anyone exceed the original purchase price of the materials (or replacement of the materials at EVGA Corporation's option). All information furnished is believed to be accurate and reliable. However, EVGA Corporation assumes no responsibility for the consequences of use of such information or for any infringement of patents or other rights of third parties that may result from its use, or use of the Software. No license is granted by implication or otherwise under any patent or patent rights of EVGA Corporation except as expressly provided herein. All specifications mentioned in this publication are subject to change without notice.